

**Makita**<sup>®</sup>

<sup>®</sup>

# ΗΛΕΚΤΡΙΚΑ ΕΡΓΑΛΕΙΑ & ΑΞΕΣΟΥΑΡ















































2026













**Makita**<sup>®</sup>



# ΤΕΧΝΟΛΟΓΙΕΣ ΤΗΣ ΜΑΚΙΤΑ

## MAKITA TECHNOLOGIES

 Double Insulation	 Torque Setting 9	 Bevel Cutting 45 LR	 Chain Brake
 Variable Speed	 Torque Setting 16	 Makita Shank Jig Saw Blade	 Anti Vibration
 Brake	 Torque Setting 18	 Bayonet Shank Jig Saw	 Revolving Hose
 Reversing	 Torque Setting 20	 Blade Laser Marker	 Static Free Hose
 Mechanical 2-Speed	 Torque Setting 21	 Orbital Cutting	 SDS-PLUS Shank
 Mechanical 3-Speed	 Torque Setting 21_41	 Hook & Loop	 SDS-MAX Shank
 Electronic 2-Speed	 Dust Collection	 Depth Adjustment	 17mm Hex Shank
 Electronic 3-Speed	 Torque Limiter	 Sequential and Bump-fire	 21mm Hex Shank
 Electronic 4-Speed	 Constant Speed	 Auto Firing Stop	 28.6mm Hex Shank
 Keyless Chuck	 Soft Start	 Automatic Oiling	 30mm Hex Shank
 Clutch-equipped	 Bevel Cutting 45 left	 Stainless Tank	 Built-in Job Light
 Torque Setting 6	 Bevel Cutting L45 R5	 Anti-restart function	

 Lithium-ion Extreme Technology	 Next Generation Technology	 Deep Exact Cutting Technology	 Suppression of Motor Speed when Idling
 Compact Extreme Technology	 Auto-Start Wireless System	 Automatic Torque Drive Technology	 Quick Change Grinding Blades
 Brushless Motor	 Anti-Vibration Technology	 Active Feedback Sensing Technology	 High water-resistance when operating



Η Makita Corporation είναι μέλος του Ευρωπαϊκού Συνδέσμου Ηλεκτρικών Εργαλείων (EPTA). Όλα τα μοντέλα αυτού του καταλόγου συμμορφώνονται με τους κανονισμούς σήμανσης CE. Όλα τα βάρη που αναφέρονται σε αυτόν τον κατάλογο είναι σύμφωνα με τη διαδικασία EPTA 01/2003. Όλοι οι αριθμοί δόνησης είναι σύμφωνα με το EN60745.



**Makita**<sup>®</sup>

THE FUTURE IS  
**POWERFUL**

## Cordless

### Αξεσουάρ - Accessories

Μπαταρίες & φορτιστές - Batteries & chargers	6
Φανάρια - Torches	10
Ραδιόφωνα - Jobsite Radios	13
Καφετιέρες / Φορητό ψυγείο & θερμαντήρας - Coffee Makers / Cooler & Warmer Box	14
Θερμαινόμενες Κουβέρτες / Ανεμιστήρες - Heated Blankets / Fans	15
Κάσιες Εργαλείων Μακρας - Makpac organiser sets	16
Τσάντες / Θήκες εργαλείων - Bags & Tool Cases	18
Γενικά Αξεσουάρ - General Accessories	20
Αξεσουάρ εργαλείων - Tool Accessories	22
Μακρας	36
Οδηγοί ευθείας - Guide Rail	48

### Ειδικά Εργαλεία - Special Tools

### Ηλεκτρικά Εργαλεία - Electric Tools

Ξύστρα - Scrapers	54
Περιστροφικά SDS-Plus & SDS-Max - Rotary Hammers SDS-Plus & SDS-Max	54
Δραπανοκατάρβιδα - Combi Drills	56
Κατσαβίδια - Drill Drivers	56
Γωνιακά Κατσαβίδια - Angle Drills	57
Παλημικά Κατσαβίδια - Impact Drivers	57
Βιδολόγοι - Impact wrenches	59
Κατσαβίδια/Κόφτες γυψοσανίδας - Drywall Screwdrivers/cutters	61
Κατσαβίδια αυτόματης τροφοδοσίας - Autofeed Screwdrivers	62
Καρφωτικά / Συρραπτικά - Nailers / Staplers	62
Πριτσινιαδόροι - Rivet Gun	63
Πλάνες - Planers	64
Ρούτερς - Router / Trimmers	64
Κόφτες μετάλλων - Metal Cutting saws	65
Δισκοπρίονα Πάγκου - Mitre Saws	65
Δισκοπρίονα χειρός - Circular Saws	65
Δισκοπρίονα με οδηγό - Plunge cut saw	66
Δισκοπρίονα Πάγκου - Slide compound saw	66
Πριονοκορδέλλες - Band Saws	66
Σέγες - Jigsaws	67
Φρεζοκαβιλιέρες - Biscuit jointers	68
Τριβεία / Πολισιέρες - Sanders / Polishers	68
Κόφτες κεραμικού - Tile cutters	68
Σπαθόσεγες - Reciprocating Saws	69
Πολυεργαλεία - Multi Tools	70
Γωνιακοί Τροχοί - Angle Grinders	71
Λειαντήρες - Die Grinders	72
Ψαλίδια - Nibbler	72
Κόφτες δομικών υλικών - Disc Cutters	72
Αναδευτήρες - Mixers	72
Γρασέρες / Πιστόλια Σιλικόνης - Grease gun / Caulking	72
Κομπρεσόροι - Compressors	73
Πολυκόφτης /Κόφτης Ατσάλινων ράβδων - Multi cutter / Rebar Cutter	73
Εργαλείο Δεσίματος οίκ/κού σιδήρου - Rebar Tying Tool	73
Απορροφητικές Αντλίες - Vacuum Pumps	75
Πλυστικά υψηλής ισχύος - Power Washers	75
Απορροφητικές σκούπες καθαρισμού - Dust Extractor / Vacuums	76
Όργανα μέτρησης - Laser Measuring	78
Χειράμαξα - Wheelbarrow	79

### Σετ εργαλείων - Combo Deals

40V XGT

80

84

## Corded

### Drills - Τρυπάνια

Γωνιακά Κατσαβίδια - Angle Drills	90
Κατσαβίδια - Drill Drivers	90
Δραπανοκατάρβιδα - Combi Drills	90
Περιστροφικά τρυπάνια - Rotary Drills	90
Κρουστικά τρυπάνια - Percussion Drills	90
Περιστροφικά SDS-Plus - Rotary Hammers SDS-Plus	92

### Demolition - Κατεδαφιστικά

Περιστροφικά SDS-Max - Rotary Hammers SDS-Max	94
Κατεδάφιστικά - Demolition Hammers	95

### Construction - Επεξεργασία δομικών υλικών

Κόφτες δομικών υλικών Πετρελαίου - Petrol Disc Cutters	96
Αναδευτήρες - Mixers	96

### Angle Grinders - Γωνιακοί τροχοί

	98
--	----

### Heat Guns - Πιστόλια θερμού αέρα

	100
--	-----

### Metal Working - Επεξεργασία Μετάλλου

Λειαντήρες - Die Grinders	102
Ψαλίδια - Shears / Nibbler	102
Χαράκτες - Groove cutter	103
Κόφτες μετάλλων - Cut-off saws	103

### Fastening - Εργαλεία Στερέωσης

Κατσαβίδια γυψοσανίδας - Drywall Screwdrivers	104
Παλημικά Κατσαβίδια - Impact Drivers	104
Βιδολόγοι - Impact wrenches	104

### Saws - Πριόνια

Σέγες - Jigsaws	106
Σπαθόσεγες - Reciprocating Saws	106
Δισκοπρίονα χειρός - Circular Saws	107
Πριονοκορδέλλες - Band Saws	107
Δισκοπρίονα Πάγκου - Table Saws	108
Φαίτσοπρίονο - Mitre Saws	108
Δισκοπρίονο Πάγκου Συρόμενο - Slide compound saw	110

### Woodworking - Επεξεργασία Ξύλου

Τριβεία / Πολισιέρες - Sanders / Polishers	112
Πλάνες - Planers	114
Ρούτερς - Router / Trimmers	114
Φρεζοκαβιλιέρες - Biscuit jointers	115

### Multitool - Πολυεργαλείο

### Dust Management & Cleaning / Μηχανήματα Καθαρισμού

Φυστήρες - Blowers	116
Αντλίες - Pumps	117
Πλυστικά υψηλής ισχύος - Power Washers	117

## MAKITA MT

119

## MAKITA GARDEN

Θαμνοκοπτικά - Hedge Trimmers	122
Πριόνια κλαδέματος - Pruning Saws	123
Ψεκαστήρας - Garden Sprayer	123
Αλυσοπρίονα - Chainsaws	124
Χορτοκοπτικό / Θαμνοκοπτικά - Line Trimmer / Brush Cutters	125
Φυστήρες - Blowers	126

		 DC10WD		7.2V Lithium-ion	12V Lithium-ion	 DC10WA	
				€47.50	€31.00	€52.25	
				 1.5Ah BL0715	 1.3Ah BL1013	 BL0715 30min.	 BL1013 50min.
				14,4V Lithium-ion		 DC18WA	
4.0 Ah	 BL1041B	€62.30	60min.	130min.			€73.50
2.0 Ah	 BL1021B	€44.20	30min.	70min.			€81.50
						 2.0Ah BL1420G	
						 3.0Ah BL1430B	
						€41.00	
						70min.	

		 DC18RC Also available in 110V		 DC18RD Two Port Multi Fast Charger		 DC18RE CXT&LXT Dual Port Fast Charger		 DC18SF *Except BL143A		
								1-2 batteries	3-4 batteries	€279.00
								 DC18SD	 DC18SH Two Port Multi Charger	 DC18SE (Automotive)
								-	-	€158.00
12.0 Ah	 BL18120	€220.00	120min.	260min.	520min.			265min.		
9.0 Ah	 BL1890	€179.00	85min.	200min.	400min.			200min.		
6.0 Ah	 BL1860B	€142.00	55min.	130min.	260min.			130min.		
5.0 Ah	 BL1850B	€98.00	45min.	110min.	220min.			110min.		
4.0 Ah	 BL1840B	€92.00	36min.	90min.	180min.			90min.		
3.0 Ah	 BL1830B	€82.00	30min.	60min.	120min.			60min.		
2.0 Ah	 BL1820B	€75.25	24min.	45min.	90min.			45min.		

		 DC40RA		 ADP10		 DC40RA	
						€159.00	€69.50
8.0 Ah	 BL4080F	€431.00	76min.			 BL1860B BL1850B	
5.0 Ah	 BL4050F	€293.00	50min.			 BL1840B	
4.0 Ah	 BL4040	€257.00	45min.			 BL1830B	
2.5 Ah	 BL4025	€211.00	28min.			 BL1820B	
						 ADP10	
						 BL1860B BL1850B	
						 BL1840B	
						 BL1830B	
						 BL1820B	



**ΕΙΔΙΚΕΣ ΤΙΜΕΣ  
SPECIAL PRICES**

CODE	Περιγραφή / Description	Τσάντα / Bag	DC18RC	3.0Ah, 4.0Ah 5.0Ah, 6.0Ah	Τιμή / Price
<b>PP00</b>	<b>Σετ ενέργειας 18v Li-ION 3.0Ah</b> Power pack 18v Lithium-ION 3.0Ah Συμπεριλαμβάνει φορτιστή, <b>μία</b> μπαταρία και τσάντα Includes charger, <b>one</b> battery and case	✓	✓	 <b>1 x 3.0Ah</b>	<b>€177.00</b>
<b>PP01</b>	<b>Σετ ενέργειας 18v Li-ION 3.0Ah</b> Power pack 18v Lithium-ION 3.0Ah Συμπεριλαμβάνει φορτιστή, <b>δύο</b> μπαταρίες και τσάντα Includes charger, <b>two</b> batteries and case	✓	✓	 <b>2 x 3.0Ah</b>	<b>€259.00</b>
<b>PP02</b>	<b>Σετ ενέργειας 18v Li-ION 4.0Ah</b> Power pack 18v Lithium-ION 4.0Ah Συμπεριλαμβάνει φορτιστή, <b>μία</b> μπαταρία και τσάντα Includes charger, <b>one</b> battery and case	✓	✓	 <b>1 x 4.0Ah</b>	<b>€187.00</b>
<b>PP03</b>	<b>Σετ ενέργειας 18v Li-ION 4.0Ah</b> Power pack 18v Lithium-ION 4.0Ah Συμπεριλαμβάνει φορτιστή, <b>δύο</b> μπαταρίες και τσάντα Includes charger, <b>two</b> batteries and case	✓	✓	 <b>2 x 4.0Ah</b>	<b>€279.00</b>
<b>PP04</b>	<b>Σετ ενέργειας 18v Li-ION 5.0Ah</b> Power pack 18v Lithium-ION 5.0Ah Συμπεριλαμβάνει φορτιστή, <b>μία</b> μπαταρία και τσάντα Includes charger, <b>one</b> battery and case	✓	✓	 <b>1 x 5.0Ah</b>	<b>€213.00</b>
<b>PP05</b>	<b>Σετ ενέργειας 18v Li-ION 5.0Ah</b> Power pack 18v Lithium-ION 5.0Ah Συμπεριλαμβάνει φορτιστή, <b>δύο</b> μπαταρίες και τσάντα Includes charger, <b>two</b> batteries and case	✓	✓	 <b>2 x 5.0Ah</b>	<b>€331.00</b>
<b>PP06</b>	<b>Σετ ενέργειας 18v Li-ION 6.0Ah</b> Power pack 18v Lithium-ION 6.0Ah Συμπεριλαμβάνει φορτιστή, <b>μία</b> μπαταρία και τσάντα Includes charger, <b>one</b> battery and case	✓	✓	 <b>1 x 6.0Ah</b>	<b>€241.00</b>
<b>PP07</b>	<b>Σετ ενέργειας 18v Li-ION 6.0Ah</b> Power pack 18v Lithium-ION 6.0Ah Συμπεριλαμβάνει φορτιστή, <b>δύο</b> μπαταρίες και τσάντα Includes charger, <b>two</b> batteries and case	✓	✓	 <b>2 x 6.0Ah</b>	<b>€387.00</b>
<b>ZZ050</b>	<b>Τσάντα PowerPack</b> PowerPack Bag Συμπεριλαμβάνει μόνο την τσάντα Includes case only	✓	—	—	<b>€10.00</b>



## Συμβουλές για τη διατήρηση της μέγιστης διάρκειας ζωής της μπαταρίας

- 1** Αλλάξτε την μπαταρία πριν αποφορτιστεί πλήρως. Σταματάτε πάντα τη λειτουργία του εργαλείου και φορτίζετε την μπαταρία όταν παρατηρείτε λιγότερη ισχύ του εργαλείου.
- 2** Ποτέ μην επαναφορτίζετε μια πλήρως φορτισμένη μπαταρία. Η υπερφόρτιση μειώνει τη διάρκεια ζωής της μπαταρίας.
- 3** Φορτίστε την μπαταρία με θερμοκρασία δωματίου στους 10 °C - 40 °C (50 °F - 104 °F). Αφήστε μια ζεστή μπαταρία να κρυώσει πριν τη φορτίσετε.
- 4** Φορτίστε την μπαταρία εάν δεν τη χρησιμοποιείτε για μεγάλο χρονικό διάστημα (περισσότερο από έξι μήνες).

## Φροντίστε να χρησιμοποιείτε μόνο αυθεντικές μπαταρίες Li-Ion της Makita.

Όταν χρησιμοποιείτε μη αυθεντικές μπαταρίες Li-Ion Makita, υπάρχει επίσης ο κίνδυνος:

- Η έκρηξη της μπαταρίας μπορεί να προκαλέσει τραυματισμό ή / και υλικές ζημιές
- Πιθανή ζημιά από φωτιά στο εργαλείο, στην μπαταρία και / ή στον φορτιστή
- Άγνωστη απόδοση εργαλείου

Η Makita δεν φέρει καμία ευθύνη για ατυχήματα, τραυματισμό ή υλική ζημιά (ή ζημιά σε μπαταρίες, εργαλεία ή φορτιστές) που προκύπτει ως αποτέλεσμα της χρήσης μη αυθεντικών μπαταριών.

Makita  
Corporation



194649-7

€7.80

Προστατευτικό μπαταρίας BL18

Battery Protector for batteries BL18

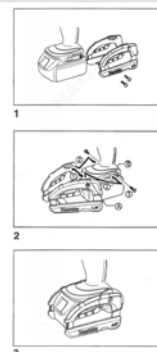

## Tips for maintaining maximum battery life

- 1** Change the battery cartridge before completely discharged. Always stop tool operation and charge the battery cartridge when you notice less tool power.
- 2** Never recharge a fully charged battery cartridge. Overcharging shortens the battery service life.
- 3** Charge the battery cartridge with room temperature at 10 °C - 40 °C (50 °F - 104 °F). Let a hot battery cartridge cool down before charging it.
- 4** Charge the battery cartridge if you do not use it for a long period (more than six months).

# ΑΞΕΣΟΥΑΡ

## ACCESSORIES



# LIGHTS

ΕΠΑΝΑΦΟΡΤΙΖΟΜΕΝΑ ΦΑΝΑΡΙΑ

# ON!



- Built-in USB port for charging portable devices

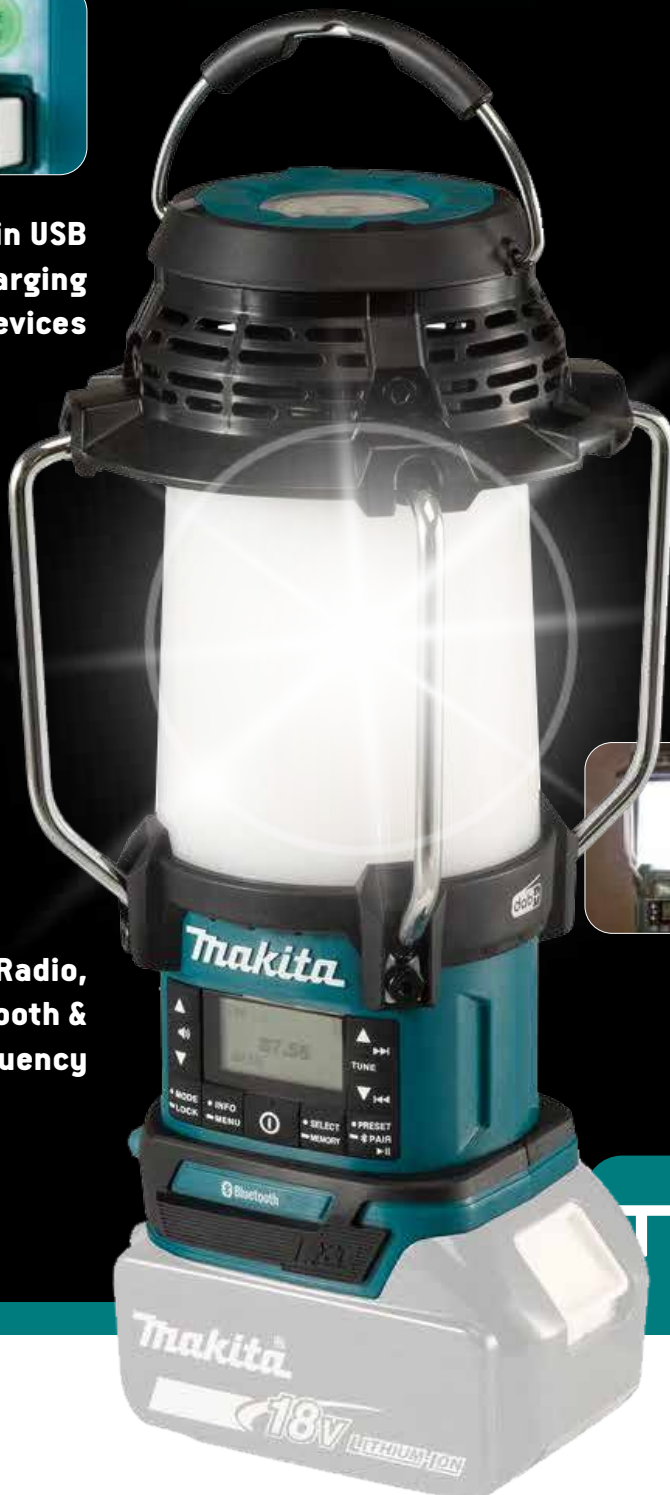

- Digital Radio, Bluetooth & FM radio frequency



## DMR056

- 4 light modes:
  - 360° lantern,
  - 270° lantern
  - Flashlight or
  - Strobe



THE RANGE >>

## DML801

€56.00

Φανάρι Μπαταντζά LED 240lm

Rechargeable LED flashlight 240lm

14.4v / 18v Lithium-ION

0.37kg

15hrs/BL1850

Ρυθμιζόμενη κατεύθυνση φωτισμού

Adjustable light direction

Δεν συμπεριλαμβάνει μπαταρία και φορτιστή  
Does not include battery and charger

**LITHIUM-ION LXT**



## DML815

€38.00

Φανάρι LED 160lm

Rechargeable LED flashlight 160lm

18v Lithium-ION

0.33kg

54hrs/BL1860B

Ρυθμιζόμενη κατεύθυνση φωτισμού

Adjustable light direction

Δεν συμπεριλαμβάνει μπαταρία και φορτιστή  
Does not include battery and charger

**LITHIUM-ION LXT**



## DML806

€71.00

Φανάρι Μπαταντζά LED 620lm

Rechargeable LED flashlight 620lm

14.4v / 18v Lithium-ION

0.73kg

Full 620lm : 11hrs/BL1850

Half 310lm : 21hrs/BL1850

Flash 90lm : 59hrs/BL1850

3 στάδια φωτεινότητας LED

3 stage LED brightness

Δεν συμπεριλαμβάνει μπαταρία και φορτιστή  
Does not include battery and charger

**LITHIUM-ION LXT**



## DML805

€210.00

Προβολέας LED 750lm AC/DC

Corded and cordless led worklight

14.4v / 18v Lithium-ION

3.00 Kg

10hrs/BL1850

Ρυθμιζόμενη κατεύθυνση φωτισμού

Adjustable light direction

Power supply cord 2.5m

Δεν συμπεριλαμβάνει μπαταρία και φορτιστή  
Does not include battery and charger

**LITHIUM-ION LXT**



## ML104

€127.50

Φανάρι Μπαταντζά LED 710lm

Rechargeable LED flashlight 710lm

12.0v Lithium-ION

0.61 Kg

360° / 710lm : 5.5hrs/BL1041B

90° / 190lm : 21hrs/BL1041B

Flash 130lm : 59hrs/BL1041B

360 degree illumination with 20 bright white LED's

Ρυθμιζόμενη κατεύθυνση φωτισμού

Δεν συμπεριλαμβάνει μπαταρία και φορτιστή  
Does not include battery and charger

**LITHIUM-ION CXT**



## GM0002283

€86.85

Τρίποδας για DML805

Tripod for DML805

Στον τρίποδα μπορούν να τοποθετηθούν έως δύο προβολείς Makita DML805

Σταβαρό σχέδιο με τρία πόδια για μέγιστη σταθερότητα

Πτυσσόμενος σχεδιασμός για βέλτιστη φορητότητα

Η βάση επιτρέπει την εύκολη περιστροφή 360° του προβολέα

Ο βοηθός σχεδιασμός επιτρέπει τη γρήγορη και εύκολη εγκατάσταση και αφαίρεση των προβολέων

Ελαφριά σχεδίαση



## ML103

€36.50

Φανάρι LED 100lm

LED torch 100lm

10.8v / 12.0v Lithium-ION

14hrs / BL1021

Δεν συμπεριλαμβάνει μπαταρία και φορτιστή  
Does not include battery and charger

**LITHIUM-ION CXT**



## GM0001396

€64.30

Βάση-Σφιγκτήρας προβολέα DML805

Vice for DML805

Χρησιμοποιείται για την τοποθέτηση του DML805 σε σωήνες σκαλωσιάς κ.λ.π.



## DML812

€144.50

### Φανάρι Προβολέας LED 700lm

#### Rechargeable LED flashlight 160lm

14.4v / 18v Lithium-Ion

1.32kg

Long beam distance up to 640m

Spot, Flood, Spot+Flood, Strobe lighting modes

Variable angle head 90°

Bracket hook

Length: 313 mm Width: 119 mm Height: 115 mm

Δεν συμπεριλαμβάνει μπαταρία και φορτιστή  
Does not include battery and charger

**LITHIUM-ION LXT**



## DML808

€76.50

### Φανάρι με Εστίαση LED 160lm

#### Adjustable Beam L.E.D. Flashlight 160lm

18v Lithium-Ion

0.48 Kg

26hrs/BL1850

Λειτουργία ζουμ για ρύθμιση του εύρους φωτισμού

Zoom function to adjust the illumination range

Δεν συμπεριλαμβάνει μπαταρία και φορτιστή  
Does not include battery and charger

**LITHIUM-ION LXT**



## DML811

€307.00

### Προβολέας LED

#### LED Worklight

30 x LED

High: 3,000 lumens

Medium: 1,500 lumens

Low: 750 lumens

18V Li-ion Battery or Mains Powered 240V

Δεν συμπεριλαμβάνει μπαταρία και φορτιστή  
Does not include battery and charger

**LITHIUM-ION LXT**



## ML106

€76.50

### Φανάρι με Εστίαση LED 190lm

#### Adjustable Beam L.E.D. Flashlight 190lm

12.0v Lithium-Ion

0.45 Kg

Run Time (max. in hours) : 12

Λειτουργία ζουμ για ρύθμιση του εύρους φωτισμού

Zoom function to adjust the illumination range

Δεν συμπεριλαμβάνει μπαταρία και φορτιστή  
Does not include battery and charger

**LITHIUM-ION CXT**



## DML809

€462.00

### Προβολέας LED

#### LED Worklight

96 x LED

High: 10,000 lumens

Medium: 4,000 lumens

Low: 2,000 lumens

18V Li-ion Battery or Mains Powered 240V

Can take 2x 18V batteries for longer run times

Δεν συμπεριλαμβάνει μπαταρία και φορτιστή  
Does not include battery and charger

**LITHIUM-ION LXT** 18V + 18V → 36V



## DML818

€329.00

### Φανάρι/Φωτιστικό καπό LED

#### LED Cordless Bar Light

14.4v / 18v Lithium-Ion

High: 2,000 lumens

Medium: 800 lumens

Low: 450 lumens

Angle range horizontal: 270°

Δεν συμπεριλαμβάνει μπαταρία και φορτιστή  
Does not include battery and charger

**LITHIUM-ION LXT**

NEW



## DML810

€514.00

### Προβολέας 360° LED 5500lm AC/DC

#### Cordless/Corded upright LED area light 5500lm AC/DC

36v (18v x 2)

13.8kg

Dimensions (LxWxH) : 42 x 42 x 78.8 cm

Lumens (high/med/low) : 5,500/3,000/1,500 lm

Run Time (high/med/low) : 3.3 / 7 / 15 hrs

Dust and water-resistant construction

Self-righting design, stays in upright position

Δεν συμπεριλαμβάνει μπαταρία και φορτιστή  
Does not include battery and charger

**LITHIUM-ION LXT**



## DMR055

€142.50

### Ραδιόφωνο Φανάρι

#### Rechargeable radio/lantern

14.4v / 18v Lithium-ION

1.6kg

Frequency range FM 87.5 – 108 MHz

Frequency range AM 522 – 1,710 kHz

Lantern Light tone and colours: Warm White

Illuminance High/Low: 4 Sides 130 lx / 3 Sides 115 lx

Luminous Flux High/Low: 4 Sides 260 lm / 3 Sides 190 lm

Δεν συμπεριλαμβάνει μπαταρία και φορτιστή  
Does not include battery and charger

**LITHIUM-ION LXT**



## DMR056

€256.00

### Ραδιόφωνο Φανάρι DAB/DAB + Bluetooth

#### Rechargeable radio/lantern DAB/DAB+ Bluetooth

14.4v / 18v Lithium-ION

1.6kg

Frequency range FM 87.5 – 108 MHz

Tones: Daylight White/Neutral White/Warm White

Lant. Illuminance Hi/Lo: 145/72 / 140/70 / 130/65 lx

Lant. Luminous Flux Hi/Lo: 310/155 / 300/150 / 260/130 lm

Flashlight Illuminance High/Low : 1,000 / 500 lx

Flashlight Luminous Flux High/Low: 200/100 lm

Δεν συμπεριλαμβάνει μπαταρία και φορτιστή  
Does not include battery and charger

**LITHIUM-ION LXT** **DAB+**  
Digital Audio Broadcasting



## DMR203

€165.00

### Ηχείο Bluetooth

#### Bluetooth Speaker

Power Source: AC/DC

10.8-18V (CXT and LXT only)

3.0 kg

Woofer: 101.6mm

Tweeter 36mm

Passive radiator 89mm

Δεν συμπεριλαμβάνει μπαταρία και φορτιστή  
Does not include battery and charger

**LITHIUM-ION LXT CXT**



## MR002GZ

€275.00

### Ραδιόφωνο

#### Job side radio

12V - 40V max

5,0 - 5,3 kg

Δεν συμπεριλαμβάνει μπαταρία και φορτιστή  
Does not include battery and charger

Compatible with CXT®, LXT®, XGT®, batteries

**LITHIUM-ION LXT CXT**



## MR001G

€232.00

### Ραδιόφωνο

#### Job side radio

12V - 40V max

4,3 kg

Compatible with CXT®, LXT®, XGT®, batteries.  
Dual Power Sources: AC or Makita batteries.



Δεν συμπεριλαμβάνει μπαταρία και φορτιστή  
Does not include battery and charger

**LITHIUM-ION LXT CXT**



## MR007G

€401.00

### Ραδιόφωνο

#### Job side radio

12V - 40V max

5,3 kg

Compatible with CXT®, LXT®, XGT®, batteries.  
Dual Power Sources: AC or Makita batteries.



Δεν συμπεριλαμβάνει μπαταρία και φορτιστή  
Does not include battery and charger

**LITHIUM-ION** 18V → 36V  
**LXT CXT** **DAB+**  
Digital Audio Broadcasting



**DCM501Z****€136.50****Καφετιέρα μπαταρίας****Cordless coffee maker**

12 - 18v Lithium-ION

2.0kg

Δεν συμπεριλαμβάνει μπαταρία και φορτιστή  
Does not include battery and charger**LITHIUM-ION LXT CXT****DKT360Z****€274.50****36 (18V x2) V LXT Βραστήρας****36 (18V x2) LXT Kettle**

Water tank capacity 0.8L

2.7 - 3.4kg

Dimensions L233 x W263 x H307mm

Δεν συμπεριλαμβάνει μπαταρία και φορτιστή  
Does not include battery and charger**LITHIUM-ION 18V+18V 36V LXT****198253-4****NEW****€99.00****Παγωνιέρα Μακpac Size 4 (18L)****Μακpac Coolbox Size 4 (18L)**

Size: 395 x 295 x 320 mm

**198254-2****NEW****€88.00****Παγωνιέρα Μακpac Size 3 (11L)****Μακpac Coolbox Size 3 (11L)**

Size: 2395 x 295 x 210 mm

**CW001GZ****€944.00****18V Ηλεκτρικό φορητό ψυγείο & θερμαντήρας****18V Cordless Cooler & Warmer Box**

Cooling Capacity -18 - 10 °C

Warming Capacity 50 - 60 °C

Capacity 20 L

Weight 13.0 - 14.3 kg

**Run Time 2x 6.0Ah**

5 hours (at -18 °C)

17 hours (at 5 °C)

4 hours (at 60 °C)

Δεν συμπεριλαμβάνει μπαταρία και φορτιστή  
Does not include battery and charger

**CB100DA/B** ΜΕΧΡΙ ΕΞΑΝΤΛΗΣΙΩΣ  
UNTIL STOCK LASTS **€155.00**

12Vmax Θερμαινόμενη κουβέρτα

12Vmax Cordless Heated Blanket

0.58kg

70x140cm

CB100DA

CB100DB

3 ρυθμίσεις θερμότητας (υψηλή / μεσαία / χαμηλή)

αντοχή στον αέρα και το νερό

3 heat settings (high/medium/low)

wind and water resistance

Δεν συμπεριλαμβάνει μπαταρία και φορτιστή  
Does not include battery and charger

**LITHIUM-ION 12Vmax CXT**



Φορτίζει έως και 2  
ηλεκτρονικές συσκευές  
συμβατές με USB

Charges up to 2 USB compatible electronic devices



**DECADPO5**

**€29.00**

18V USB προσαρμογέας

18V USB adapter

2 x USB ports (A type), Provides 2.1A per USB port

Strap installation hole, Belt clip

Φορτίζει ή τροφοδοτεί ενέργεια σε τηλέφωνα,  
tablet και άλλες συσκευές USB όταν  
χρησιμοποιείται με μπαταρίες λιθίου 14.4v / 18v

Charges or supplies power to smart phones,  
tablets and other USB device's when used with  
14.4V / 18V Li-ion batteries

Δεν συμπεριλαμβάνει μπαταρία και φορτιστή  
Does not include battery and charger

**LITHIUM-ION LXT**



**DCF102Z** ΜΕΧΡΙ ΕΞΑΝΤΛΗΣΙΩΣ  
UNTIL STOCK LASTS **€125.00**

18V Ανεμιστήρας μπαταρίας

18V Cordless Fan

1.3 - 2.0 kg

(LxWxH) 185x272x284mm

Air Flow (H/M/L) 4.6 / 3.8 / 3.0 m<sup>3</sup>/min

Max Air Speed (Hi) 180 m/min

(Med) 150 m/min (Lo) 120 m/min

Continuous Usage Time (approx)

Low: 1,270min | Med: 705min | High 575 min

with BL1860B

Δεν συμπεριλαμβάνει μπαταρία και φορτιστή  
Does not include battery and charger

**LITHIUM-ION 12Vmax CXT**



**DCF203Z**

**€177.00**

14.4/18V Ανεμιστήρας μπαταρίας

14.4/18V Cordless Fan

2.1 - 2.4 kg

(LxWxH) 333x140x447mm

Air Flow (max): 5,2 - 8,2m<sup>3</sup>/min

Three speed settings (High/Medium/Low)

Oscillation selector for optimal air velocity and control

Designed for reduced wind noise level for quiet operation

3-stage automatic timer with 1, 2, and 4 hour power-off selection

AC adapter included

Continuous Usage Time (approx)

Low: 1,010min | Med: 650min | High 410 min

with BL1850B

Δεν συμπεριλαμβάνει μπαταρία και φορτιστή  
Does not include battery and charger

**LITHIUM-ION LXT**

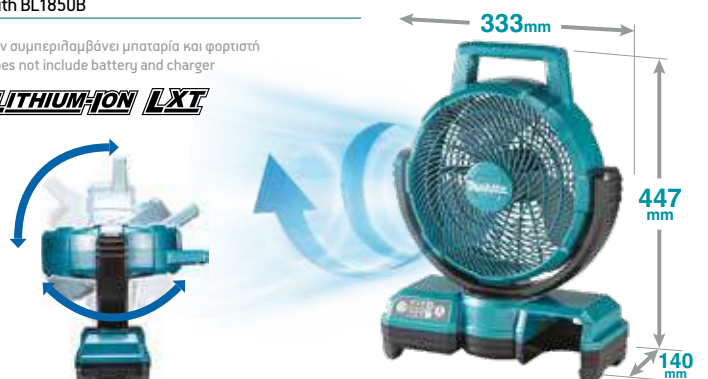

**191X80-2****€83.50**

Κάσια Εργαλείων Μακpac 1 με 13 θήκες

**Μακpac organiser set**

This set includes 13 insert boxes:

1x 150x150mm

1x 100x150mm

2x 100x100mm

3x 50x100mm

6x 50x50mm

(H) 105 mm x (L) 295 mm x (W) 395 mm

**Transparent lid**

Easily see through the inner box storage items

**Interlocking System**

Easy storage &amp; transportation

**191X84-4****€69.00**

Κάσια Εργαλείων Μακpac 1 (χωρίς θήκες)

**Μακpac organiser set (no boxes)**

(H) 105 mm x (L) 295 mm x (W) 395 mm

**191X93-3****€1.10**

θήκη 50 X 50 mm για κάσια 191X80-2 / 84-4

Box 50x50 mm set

**191X94-1****€1.50**

θήκη 50 X 100 mm για κάσια 191X80-2 / 84-4

Box 50x100 mm set

**191X95-9****€2.15**

θήκη 100 X 100 mm για κάσια 191X80-2 / 84-4

Box 100x100 mm set

**191X96-7****€2.90**

θήκη 100 X 150 mm για κάσια 191X80-2 / 84-4

Box 100x150 mm set

**191X97-5****€3.25**

θήκη 150 X 150 mm για κάσια 191X80-2 / 84-4

Box 150x150 mm set



**P-84349**

**€287.00**

Κάσια Εργαλείων Makpac Size 4 (5 συρτάρια)

**Μakpac Drawer-Systainer Size 4**

Makpac case with 5 drawers for easier clarity and organisation of items including screws, plugs and other auxiliary materials.

Easy to connect with other Makpac cases in the range

Size: 295 x 395 x 320mm



**P-84333**

**€234.50**

Κάσια Εργαλείων Makpac Size 3 (6 συρτάρια)

**Μakpac Drawer-Systainer Var.4 Size 3**

Makpac case with 6 drawers for easier clarity and organisation of items including screws, plugs and other auxiliary materials.

Easy to connect with other Makpac cases in the range

Size: 295 x 395 x 210mm



**P-84327**

**€248.00**

Κάσια Εργαλείων Makpac Size 3 (12 συρτάρια)

**Μakpac Drawer-Systainer Var.3 Size 3**

Makpac case with 12 drawers for easier clarity and organisation of items including screws, plugs and other auxiliary materials.

Easy to connect with other Makpac cases in the range

Size: 295 x 395 x 210mm



**P-84311**

**€205.00**

Κάσια Εργαλείων Makpac Size 3 (4 συρτάρια)

**Μakpac Drawer-Systainer Var.1 Size 3**

Makpac case with 4 drawers for easier clarity and organisation of items including screws, plugs and other auxiliary materials.

Easy to connect with other Makpac cases in the range

Size: 295 x 395 x 210mm

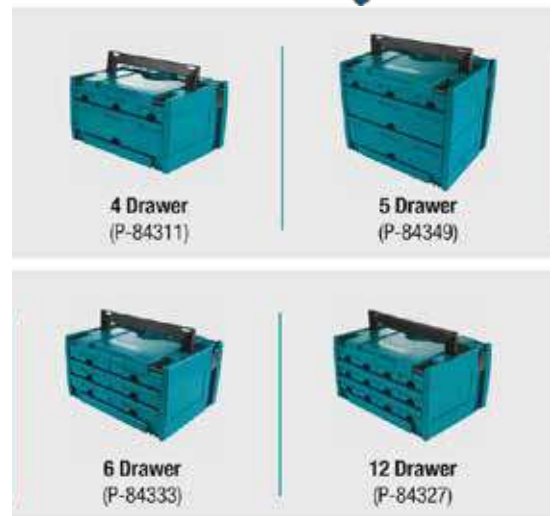
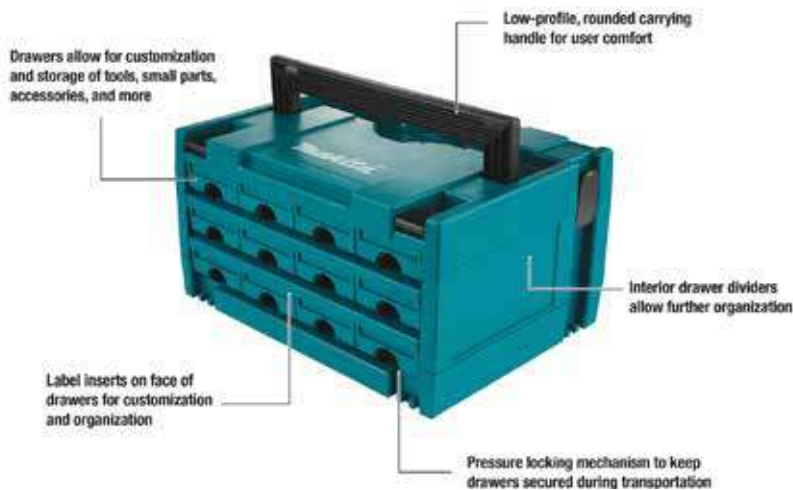

**P-83842**

**€85.00**

Κάσια Εργαλείων Makpac 4 ανοιχτή με χέρι

**Μakpac Tool Carry All 250mm**

Stackable toolbox which will connect to you existing MAKPAC cases or trolley.

Size: 295 x 395 x 310 mm



**P-83836**

**€72.00**

Κάσια Εργαλείων Makpac 3 ανοιχτή με χέρι

**Μakpac tool box, small**

Stackable Tool Box

Size: 295 x 395 x 225 mm



**P-84137****€97.90**

Κάσια Εργαλείων πλαστική 16"

Plastic tool box 16"

Height	234mm
Length	396mm
Width	296mm

Compatible with all Makpac connector case systems

Equipped with 1x Makpac 5PC Storage Insert (P-84171)

**823333-4****€90.00**

Μεταλλική Βαλίτσα για αλυσοπρίονα

Metal storage case for electric chainsaws

**NEW**

Height	480mm
Length	580mm
Width	230mm

**E-15425****€98.20**

Τσάντα εργαλείων υφασμάτινη - 510mm

Ultimate Gate Mouth Tool Bag - 510mm

Height	280mm
Length	510mm
Width	295mm
Weight	2,18kg
Capacity	34,30 L



STRAP/BELT SYSTEM

WATERPROOF BOTTOM

ELASTIC LOOPS

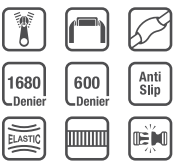
 Δεν συμπεριλαμβάνει τα εργαλεία  
Tools not included
**832319-7****€23.45**

Τσάντα εργαλείων υφασμάτινη - 360mm

Ultimate Gate Mouth Tool Bag -360mm

**NEW**

Height	220mm
Length	360mm
Width	270mm

**199901-8****€39.00**

Βαλίτσα Εργαλείων - 630mm

Tool Bag

Height	230mm
Length	630mm
Width	190mm

**832366-8****€60.00**

Τσάντα εργαλείων υφασμάτινη - 700mm

Large Tool Bag- 700mm

Height	320mm
Length	700mm
Width	310mm

**832367-6****€65.00**

Τσάντα εργαλείων υφασμάτινη - 700mm με τροχούς

Large Tool Bag- 700mm with wheels

**NEW**

Height	300mm
Length	700mm
Width	350mm

**E-05577****€110.00**

Τσάντα πολλαπλής χρήσης - κλείσιμο με ρολό

Roll-top all weather duffel bag

**NEW**

Height	250mm
Length	610mm
Width	300mm
Weight	1.72kg
Capacity	37,00 L

CS BACKPACK CARRYING SYSTEM

STRAP/BELT SYSTEM

ANTI SLIP

Κλείσιμο με ρολό επιτρέπει να προσαρμόσετε το μέγεθος στο περιεχόμενο

Roll-top adapts to content size



**831278-2**

**€52.00**

Τσάντα εργαλείων βαρέου τύπου ρούκενν 24"

Heavy duty tool bag 24"



**831279-0**

**€70.00**

Τσάντα εργαλείων βαρέου τύπου ρούκενν 27,5" με τροχούς

Heavy duty tool bag 27,5" with wheels



**E-15481**

**€165.00**

Επαγγελματικό σακίδιο εργαλείου πλάτης 560mm

Backpack tool organiser 560mm

Height	225mm
Length	560mm
Width	390mm
Weight	2.56kg



Δεν συμπεριλαμβάνεται τα εργαλεία  
Tools not included

**E-15584**

**€41.50**

Τσάντα φαγητού 7.5L

Lunch Bag

Height	210mm
Length	330mm
Width	180mm
Weight	0,45kg
Capacity	7,50 L



**3 LAYERS**

**E-15372**

**€52.80**

Τιράντες Ζώνης Εργασίας

Ultimate padded braces

Height	410mm
Length	520mm
Width	23mm
Weight	0.47kg



**E-15506**

**€44.70**

Βαήτσα Εργαλείων Αναδ/νν - 30 Θήκες

Tool Organiser Wrap - 30 Pockets

Height	195mm
Length	350mm
Width	45mm
Weight	0.75kg



**E-15366**

**€58.60**

Ζώνη Εργασίας

Ultimate padded belt & loop

Height	100mm
Length	880mm
Width	30mm
Weight	0.66kg



**E-05359**

**€32.30**

Δερμάτινη ζώνη MEDIUM 1130mm

Leather belt black MEDIUM 1130mm

**E-05365**

**€32.40**

Δερμάτινη ζώνη LARGE 1130mm

Leather belt black LARGE 1330mm



**E-15198****€53.45**

Θήκη Εργαλείων Μέσος

Ultimate 2 Pocket Fixing Pouch

Height	270mm
Length	260mm
Width	145mm
Weight	0.44kg



Δεν συμπεριλαμβάνει τα εργαλεία  
Tools not included

**E-15285****€31.35**

Θήκη Εργαλείων Μέσος

Ultimate 3-Way Hammer &amp; Tool Holder

Height	205mm
Length	185mm
Width	85mm
Weight	0.29kg



Δεν συμπεριλαμβάνει τα εργαλεία  
Tools not included

**E-15615****€42.00**

Επιγονατίδες

Knee pad set light duty

Height	240mm
Length	170mm
Width	30mm
Weight	0.52kg

**E-05658****€50.00**

Επιγονατίδες βαρέου τύπου

Ultimate Knee pad set heavy duty

Height	240mm
Length	170mm
Width	95mm
Weight	0.52kg

**E-15578****€25.25**

Ποτήρι-θέρμος 400ml S/S

SS Thermal Mug 400ml &amp; Holder

**E-15562****€44.40**

Θέρμος 330ml &amp; Θήκη Ζώνης

Thermal Flask 330ml &amp; Holder



**E-15497****€45.15**

Υφασμάτινη επένδυση κουβά με 19 θήκες για εργαλεία

Bucket tote 19 pocket tool organiser

Height	320mm
Length	470mm
Width	80mm
Weight	0,71kg
Litres	3.201L



 Δεν συμπεριλαμβάνει τον κάδο  
Bucket not included

**B-28896-6****€18.20**

Σετ κατασβίδι με μύτες

Screw Bit Set

+ H/Tool 18pcs

Set includes:  
25mm Bits: PZ1,PZ2(x2),PZ3/  
PH1,PH2(x2),PH3  
50mm Bits: PZ1,PZ2,PZ3/PH1,PH2,  
PH3/SL4,SL5,SL6  
60mm Quick Change Bit Holder

**P-84595/604/610****NEW****€42.00**

Γάντια εργασίας με παλάμη από γνήσιο δέρμα

Palm Performance Gloves

P-84595	Medium
P-84604	Large
P-84610	X Large

- 100% genuine leather
- Durahide Leather™ technology on the palm, thumb saddle and fingertips for a breathable, ready to wear glove with no break in time
- Padded knuckles for added protection
- High abrasion resistance
- Large & flexible TRP hook & loop closure

**P-84626/632/648****NEW****€33.00**

Γάντια εργασίας δερμάτινα

Cow Driver Gloves

P-84626	Medium
P-84632	Large
P-84648	X Large

- 100% genuine leather
- Durahide Leather™ technology on the palm, thumb saddle and fingertips for a breathable, ready to wear glove with no break in time
- Water resistant
- Oil and fluid resistant
- Open cuff design for easy slip-on

**P-84654/660/676****NEW****€25.90**

Γάντια εργασίας

Open Cuff Working Gloves

P-84654	Medium
P-84660	Large
P-84676	X Large

- High dexterity for flexibility, easy movement and better control
- Touchscreen compatible for phone
- Open cuff design for easy slip-on and removal
- Breathable material for comfort
- Machine washable

**P-84682/698/707****NEW****€10.80**

Γάντια εργασίας Νιτριλίου

FitKnit™ Cut Level 1 Nitrile Coated Dipped Gloves

P-84682	Medium
P-84698	Large
P-84707	X Large

- FitKnit™ material for optimal flexibility and protection
- Touchscreen compatible for phone
- High abrasion resistance
- High dexterity for flexibility
- Advanced Nitrile coated palm for better grip
- Oil and fluid resistant
- Breathable, seamless 15-gauge FitKnit™ material for comfort and a snug fit
- Machine washable

**P-84713/729/735****NEW****€19.45**

Γάντια εργασίας Νιτριλίου

Advanced FitKnit™ Cut Level 7 Nitrile Coated Dipped Gloves

P-84713	Medium
P-84729	Large
P-84735	X Large

- Advanced 10-gauge FitKnit™ material for increased cut protection, optimal flexibility and a snug fit
- Advanced nitrile coated palm for better grip
- High dexterity for flexibility
- Touchscreen compatible for phone
- High abrasion resistance
- Oil and fluid resistant
- Breathable material for comfort
- Machine washable



Impact

# PREMIER



## EXACT FITMENT

Machined bit tips fit screws with minimal variance



## ENGINEERING

Pulse Torsion Rings distribute force and prevents breakages



## UNIQUE STEEL BLEND

The carbon alloy steel blend flexes for a longer lasting bit

LASTS UP TO

**90x**  
**LONGER**  
THAN STANDARD BITS



**E-03268**

**€5.50**

50mm Μύτη PREMIER torsion PH1

50mm Impact PREMIER torsion bit PH1

Set includes:2



**E-03274**

**€6.20**

50mm Μύτη Impact PREMIER torsion PH2

50mm Impact PREMIER torsion bit PH2

Set includes:2



**E-03296**

**€6.25**

50mm Μύτη Impact PREMIER DOUBLE torsion PZ1

50mm Impact PREMIER DOUBLE torsion bit PZ1

Set includes:2



**E-03305**

**€6.25**

50mm Μύτη Impact PREMIER DOUBLE torsion PZ2

50mm Impact PREMIER DOUBLE torsion bit PZ2

Set includes:2



**E-03420**

**€8.75**

Μετάπτωση για πύσσες διπλής κίνησης 1/4" x 3/8"  
Impact PREMIER 50mm

Impact PREMIER TILT SKT ADAPTER 1/4" x 3/8" 50mm

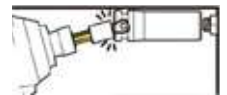

**E-03436**

**€9.35**

Μετάπτωση για πύσσες διπλής κίνησης 1/4" x 1/2"  
Impact PREMIER 50mm

Impact PREMIER TILT SKT ADAPTER 1/4" x 1/2" 50mm

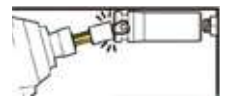

**E-20270****NEW €10.25**

Στύλος μαγνητικός Impact PREMIER ULTRAMAG 80mm

Impact PREMIER ULTRAMAG bit holder 80mm

**E-20258****€9.40**

Στύλος μαγνητικός Impact PREMIER torsion 68mm

68mm Impact PREMIER torsion bit holder

**E-20264****€12.00**

Στύλος μαγνητικός Impact PREMIER torsion 150mm

Impact Premier Torsion Bit Holder 150mm

**B-51867****NEW €37.50**

Ευκαμπτή Προέκταση Μυτών 1/4" 300mm

Flexible bit holder, 300 mm 1/4"

**E-03442****€3.60**

Μαγνήτης για μύτες Impact PREMIER

Impact PREMIER mag boost

**E-03458****€5.35**

Πίπνα Μαγνητική Impact PREMIER 1/4" Hex 6mm

Impact PREMIER Nutsetter H6x65mm

**E-03464****€5.75**

Πίπνα Μαγνητική Impact PREMIER 1/4" Hex 8mm

Impact PREMIER Nutsetter H8x65mm

**E-03470****€5.85**

Πίπνα Μαγνητική Impact PREMIER 1/4" Hex 10mm

Impact PREMIER Nutsetter H10x65mm

**E-03486****€8.25**

Πίπνα Μαγνητική Impact PREMIER 1/4" Hex 13mm

Impact PREMIER Nutsetter H13x65mm

**E-03492****€11.25**

Πίπνα Διπλής Κίνησης Impact PREMIER 1/4" Hex 13mm

Impact PREMIER TILT socket bit H13x80mm

**E-03501****€11.75**

Πίπνα Διπλής Κίνησης Impact PREMIER 1/4" Hex 15mm

Impact PREMIER TILT socket bit H15x80mm

**E-03517****€11.85**

Πίπνα Διπλής Κίνησης Impact PREMIER 1/4" Hex 17mm

Impact PREMIER TILT socket bit H17x80mm

**E-03523****€11.95**

Πίπνα Διπλής Κίνησης Impact PREMIER 1/4" Hex 19mm

Impact PREMIER TILT socket bit H19x80mm

**E-03539****€12.65**

Πίπνα Διπλής Κίνησης Impact PREMIER 1/4" Hex 21mm

Impact PREMIER TILT socket bit H21x80mm

**E-03567****€28.00**

Σετ 11τμχ μύτες με στύλο Impact PREMIER

Impact PREMIER 11PC torsion bit set

Set includes:

11pcs - 25mm Includes: PH1, PH2, PH3, PZ1, PZ2, PZ3, T15, T20, T30, Magnetic bit holder

**E-03573****€28.00**

Σετ 11τμχ μύτες με στύλο Impact PREMIER

Impact PREMIER 11PC torsion bit set

Set includes:

11pcs - 25mm Includes: PH2, PZ1, PZ2 x 2, PZ3, T20, T25, T30, SL4, SL6, Magnetic Bit Holder



# IMPACT

Impact driver's accessory series

# BLACK

▶ BLACK COATING PREVENTS RUSTING

▶ HIGH DURABILITY WITH LONGER LIFE THAN STANDARD BITS



**E-03109**

**€77.00**

Σετ Μύτες Impact Black 90 τεμ.

90pc Driver Bit Kit

Set includes:

Bits 25 mm:

5xPH1, 10xPH2, 5xPH3, 5xPZ1, 10xPZ2, 5xPZ3, 6xT15, 6xT20, 6xT25, 6xT30

Bits 50 mm:

1xPH1, 4xPH2, 2xPH3, 1xPZ1, 4xPZ2, 2xT15, 2xTL30, 2xTZ3, 2xTL30, 1xSL5,5

Socket: 6 and 8 mm

Bit holder: 60 mm



**E-22903**

**€45.00**

Σετ Μύτες Impact Black 30 τεμ.

30pc Screw Bit Kit

Set includes:

16 Bits 25 mm:

PH1, PH2 x 3, PH3, PZ1, PZ2 x 2, PZ3, T15, T20 x 2, T25 x 2, T30, T40

7 Bits 50 mm:

PH2 x 2, PZ2, T20 x 2, T25, T30

Magnetic Bit Holder 1/4" Hex 60mm

3 Nutsetters E-form 8, 10, 13mm

2 Impact Sockets 3/8" 17 & 19mm

Socket Adapter 3/8" SQ



**E-22919**

**€33.00**

Σετ Μύτες με στύλο Impact Black 32 τεμ.

32pc Screw Bit Kit

Set includes:

24 Bits 25 mm:

PH1, PH2 x 4, PH3, PZ1, PZ2 x 3, PZ3, T10, T15, T20 x 3, T25 x 3, T30 x 3, T40 x 2

7 Bits 50 mm:

PH2 x 2, PZ2, T20 x 2, T25, T30

Magnetic Bit Holder 1/4" Hex 60mm



**E-22925**

**€39.70**

Σετ Μύτες τραπεζακίου Impact Black 36 τεμ.

36pc Screw Bit Kit

Set includes:

24 Bits 25 mm:

PH1, PH2 x 4, PH3, PZ1, PZ2 x 3, PZ3, T10, T15, T20 x 3, T25 x 3, T30 x 3, T40 x 2

8 Bits 50 mm:

PH2 x 2, PZ2, T20 x 2, T25 x 2, T30

Magnetic Bit Holder 1/4" Hex 60mm

3 Nutsetters E-form 8, 10, 13mm



**B-66830** €2.65

Πίπνα μαγνητική Impact BLACK 1/4" Hex 8mm

8mm Impact black nutsetter



**B-66846** €2.75

Πίπνα μαγνητική Impact BLACK 1/4" Hex 10mm

10mm Impact BLACK nutsetter



**B-66852** €2.90

Πίπνα μαγνητική Impact BLACK 1/4" Hex 13mm

13mm Impact BLACK nutsetter



**E-15768** €23.80

Σετ πίπνες 6 τεμ. 1/4" Impact Black

6PC SET Impact BLACK nutsetters 1/4"

Set includes:  
6, 7, 8, 10, 12, 13mm



**B-66868** €2.75

Μετάπτωση για πίπνες Impact BLACK 1/4" Hex 3/8"

Impact BLACK 3/8" drive adapter



**B-66874** €3.50

Μετάπτωση για πίπνες Impact BLACK 1/4" Hex 1/2"

Impact BLACK 1/2" drive adapter



**B-66818** €4.50

Στύλος μαγνητικός πτυσσόμενος 80mm

Impact BLACK screw guide



**B-54667** €2.40

Μετατροπέας από εξάγωνο σε τετράγωνο 1/4" - 3/8"

3/8" Square Drive Socket Adapter

Overall Length 50 mm



**B-63725** €3.30

50mm Μύτη μαύρη PH2

50mm Impact black PH2

Set includes: 2



**B-63753** €3.25

50mm Μύτη μαύρη PZ2

50mm Impact BLACK PZ2

Set includes: 2



**B-63806** €2.90

50mm Μύτη μαύρη T30

50mm Impact BLACK T30

Set includes: 2



**B-63616** €2.20

25mm Μύτη μαύρη PH2

25mm Impact BLACK PH2

Set includes: 2



**B-63644** €2.15

25mm Μύτη μαύρη PZ2

25mm Impact BLACK PZ2

Set includes: 2



**B-63694** €2.00

25mm Μύτη μαύρη T30

25mm Impact BLACK T3

Set includes: 2



**E-12360** €16.60

Μύτες PH2 X 25mm 25τεμ Impact BLACK

25PC Set Impact BLACK PH2 25mm



**E-12407** €12.25

Μύτες PH2 X 50mm 10τεμ Impact BLACK

10PC Set Impact BLACK PH2 50mm



**E-12376** €16.60

Μύτες PZ2 X 25mm 25τεμ Impact BLACK

25PC Set Impact BLACK PZ2 25mm



**P-38526****€11.50**

11pc 25mm Σετ Μύτες Κατσαβιδιών

11pc 25mm Screwdriver bit set

Set includes:

10 - 25mm(L) Bits, 1 - 60mm Bit Holder  
 3-Phillips: PH1, PH2, PH3. 3-Pozi: PZ1, PZ2, PZ3  
 4-Slotted: 4.5mm, 5.5mm, 6.5mm, 8mm

**P-49046****€25.25**

11pc 25mm Σετ Μύτες Κατσαβιδιών

11pc 25mm Screwdriver bit set

Set includes:

11x 25mm Screwdriver bits, Bit Holder  
 4-Phillips: PH1, PH2, PH2, PH3  
 Pozi: PZ1, PZ2, PZ2, PZ3  
 2-Slotted: 3.5, 5.5mm

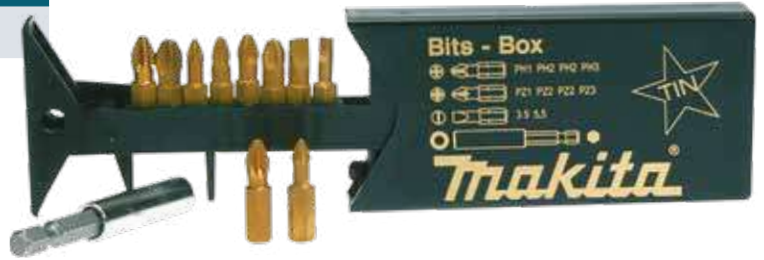
**E-07076****€26.50**

Σετ Μύτες τραπεζακιού 32 τεμ.

32pc Bit Set in a Clear Case

Set includes:

7 x 75mm screw bits - sizes:  
 PZ1, PZ2, PH1, PH2, T30, SL0.8x5.5  
 & SL1.2x6.5

24 x 25mm screw bits - sizes:  
 PZ0, PZ1, PZ2 x 2, PZ3, PH0, PH1,  
 PH2 x 3, PH3, SL0.5x3, SL0.5x4,  
 SL0.8x5.5, SL1.2x6.5, T10, T15,  
 T20, T25, T30, HEX3, HEX4, HEX5  
 & HEX6;

1 x magnetic bit holder



Application:

Screwdriving, masonry, maintenance, metal,  
 wood, masonry, impact drivers.

**D-30667-12****€13.00**

Σετ μύτες 31τεμ.

31pc Screw Bit Set

Set includes:

25mm "standard" screwdriver bits:  
 2xPh1, 4xPh2, Ph3, 2xPz1, 5xPz2, Pz3, 2xT10,  
 2xT15, 2xT20, 3xT25, 2xT30, T40, SI4, SI5.5,  
 SI6.5, Sleeve Chuck Bit Holder

**P-65779****€25.00**

Σετ μύτες 50τεμ. PZ2 50mm

50pc TUB PZ2 50mm

- The most cost effective way to buy these excellent quality bits. Can be used in impact drivers
- Star Rating: \*\*\*\*
- Application: Screwdriving, assembly, furniture, cabinet making, joinery, carpentry, pozidrive
- Features: 50 High quality Pozi 2 50mm bits packed in Candy tub. Made to DIN standard.
- Contains: 50x 50mm Pozi 2 bits.





<b>P-66569</b>	5mm	<b>€10.10</b>
<b>P-66575</b>	6mm	<b>€10.80</b>
<b>P-66581</b>	7mm	<b>€11.55</b>
<b>P-66597</b>	8mm	<b>€11.95</b>
<b>P-66612</b>	10mm	<b>€13.65</b>
<b>P-66709</b>	12mm	<b>€14.80</b>
<b>P-66715</b>	15mm	<b>€16.85</b>
<b>P-66721</b>	20mm	<b>€18.80</b>
<b>P-66737</b>	25mm	<b>€21.75</b>
<b>P-66628</b>	6, 8, 10mm	<b>€34.95</b>

Αρίδες Κεραμικού Υγρής Κοπής

Wet cutting drill bit for ceramics



<b>D-15942</b>	4mm	<b>€3.25</b>
<b>D-15958</b>	5mm	<b>€3.50</b>
<b>D-15964</b>	6mm	<b>€3.65</b>
<b>D-15970</b>	8mm	<b>€4.00</b>
<b>D-15986</b>	10mm	<b>€4.85</b>

Αρίδα Γυαλιού

Glass drill bit



**E-08698** **NEW** **€24.00**

Σετ αρίδες φτερωτές Ξύλου 8τεμ.

Performance Flat Bit 8pc Set

Set includes:

8 - Flat bits  
150mm(L):12,14,16,18,22,25,32mm



**P-46090** **€19.80**

Σετ αρίδες φτερωτές Ξύλου 5τεμ.

Performance Flat Bit 5pc Set

Set includes:

5 - Flat bits  
300mm(L):16,18,22,25,32mm



Μακρύ μήκος  
LONG LENGTH

<b>D-40082</b>	4-12mm 1/4" HEX	<b>€18.45</b>
<b>D-40098</b>	4-20mm 1/4" HEX	<b>€35.00</b>
<b>D-40107</b>	4-32mm 6mm 3 Flat	<b>€75.00</b>
<b>D-40113</b>	HSS 4-12mm 1/4" HEX	<b>€20.20</b>
<b>D-40129</b>	HSS 4-20mm 1/4" HEX	<b>€36.10</b>
<b>D-40135</b>	HSS 4-32mm 6mm 3 Flat	<b>€93.35</b>

Αρίδες κώνος

Step drill bits



<b>D-51188</b>	33mm	<b>€10.25</b>
<b>D-51194</b>	43mm	<b>€10.55</b>
<b>D-51203</b>	53mm	<b>€12.50</b>
<b>D-51219</b>	63mm	<b>€15.70</b>
<b>D-51225</b>	67mm	<b>€15.80</b>
<b>D-51231</b>	73mm	<b>€15.50</b>
<b>D-51247</b>	83mm	<b>€17.30</b>
<b>D-51253</b>	Βάση Πριονιών τρύπας Καρβιδίου Hole saw adaptor	<b>€9.35</b>
<b>D-51269</b>	Αρίδα Πριονιών τρύπας Καρβιδίου Hole saw carbide pilot drill	<b>€4.20</b>

Πριόνι τρύπας Καρβίδιο

Tungsten Carbide Holesaw



<b>E-03632</b>	16mm	<b>€6.85</b>	<b>E-03872</b>	60mm	<b>€18.50</b>
<b>B-11271</b>	19mm	<b>€10.55</b>	<b>E-03888</b>	64mm	<b>€22.10</b>
<b>B-11287</b>	20mm	<b>€8.50</b>	<b>E-03894</b>	65mm	<b>€19.90</b>
<b>E-03676</b>	22mm	<b>€11.00</b>	<b>E-03903</b>	68mm	<b>€19.90</b>
<b>E-03682</b>	24mm	<b>€11.10</b>	<b>E-03919</b>	70mm	<b>€19.95</b>
<b>E-03698</b>	25mm	<b>€11.30</b>	<b>E-03925</b>	73mm	<b>€18.70</b>
<b>E-03713</b>	29mm	<b>€11.55</b>	<b>E-03931</b>	76mm	<b>€23.40</b>
<b>E-03729</b>	30mm	<b>€14.00</b>	<b>E-03947</b>	79mm	<b>€25.15</b>
<b>E-03735</b>	32mm	<b>€12.75</b>	<b>E-03953</b>	83mm	<b>€20.90</b>
<b>E-03741</b>	35mm	<b>€12.20</b>	<b>E-03975</b>	92mm	<b>€31.50</b>
<b>E-03763</b>	38mm	<b>€12.80</b>	<b>E-03997</b>	102mm	<b>€33.50</b>
<b>E-03779</b>	40mm	<b>€12.70</b>	<b>E-04008</b>	105mm	<b>€33.50</b>
<b>E-03785</b>	41mm	<b>€12.20</b>	<b>E-04020</b>	114mm	<b>€40.10</b>
<b>E-03791</b>	44mm	<b>€14.20</b>	<b>E-04036</b>	121mm	<b>€49.00</b>
<b>E-03800</b>	46mm	<b>€13.30</b>	<b>E-04042</b>	127mm	<b>€48.00</b>
<b>E-03822</b>	51mm	<b>€14.50</b>	<b>E-04058</b>	140mm	<b>€49.40</b>
<b>E-03844</b>	54mm	<b>€19.85</b>	<b>E-04064</b>	152mm	<b>€53.30</b>
<b>E-03866</b>	57mm	<b>€20.35</b>			

Πριόνι τρύπας

Ezychange hole saw



<b>E-06644</b>	20mm	<b>€21.95</b>	<b>E-06753</b>	64mm	<b>€40.00</b>
<b>E-06650</b>	22mm	<b>€22.95</b>	<b>E-06769</b>	67mm	<b>€41.30</b>
<b>E-06666</b>	25mm	<b>€22.95</b>	<b>E-06775</b>	68mm	<b>€41.75</b>
<b>E-06672</b>	32mm	<b>€25.00</b>	<b>E-06781</b>	70mm	<b>€42.60</b>
<b>E-06688</b>	35mm	<b>€25.00</b>	<b>E-06797</b>	73mm	<b>€42.00</b>
<b>E-06694</b>	38mm	<b>€27.70</b>	<b>E-06806</b>	76mm	<b>€43.75</b>
<b>E-06703</b>	40mm	<b>€27.70</b>	<b>E-06812</b>	83mm	<b>€45.40</b>
<b>E-06719</b>	44mm	<b>€29.00</b>	<b>E-06828</b>	102mm	<b>€68.30</b>
<b>E-06725</b>	51mm	<b>€31.00</b>	<b>E-06834</b>	127mm	<b>€149.00</b>
<b>E-06731</b>	54mm	<b>€38.30</b>			
<b>E-06747</b>	60mm	<b>€40.00</b>			

Πριόνι τρύπας

Ezychange T.C.T Multi-Purpose

<b>E-04086</b>	HSS-G, 7,15 x 85 mm	<b>€11.00</b>
<b>E-06840</b>	HSS-G 105mm	<b>€10.30</b>
<b>E-06856</b>	HSS-Co 105mm	<b>€14.60</b>
<b>E-06862</b>	TCT 105mm	<b>€13.60</b>

Αρίδα Πριονιών τρύπας Καρβιδίου

Pilot drill bit

<b>E-04070</b>	13mm	<b>€26.85</b>
----------------	------	---------------

Ezychange Βάση / πιλοτική αρίδα

Ezychange adapter + T.C.T pilot drill bit

<b>E-06878</b>	150mm	<b>€31.50</b>
<b>E-06884</b>	300mm	<b>€33.20</b>

Extension bar, Ezychange

<b>E-04070</b>	Στύλλος / αρίδα για πριόνι τρύπας Change adaptor Makita Ezychange	<b>€26.85</b>
<b>E-04086</b>	Αρίδα Makita Ezychange Pilot Drill Bit Ezychange	<b>€11.00</b>
<b>B-31902</b>	Στύλλος πριόνι τρύπας Makita Ezychange SDS +	<b>€32.15</b>





<b>D-14928</b>	3x80mm	<b>€2.00</b>	<b>D-14978</b>	6x110mm	<b>€3.35</b>
<b>D-14934</b>	3,2x85mm	<b>€2.00</b>	<b>D-15827</b>	8x115mm	<b>€6.00</b>
<b>D-14940</b>	4x95mm	<b>€2.10</b>	<b>D-15833</b>	10x130mm	<b>€8.40</b>
<b>D-14956</b>	4,2x95mm	<b>€2.30</b>	<b>D-15849</b>	12x150mm	<b>€13.00</b>
<b>D-14962</b>	5x105 mm	<b>€2.50</b>	<b>D-15855</b>	13x130mm	<b>€15.80</b>

Αρίδα μετάλλου 1/4" HSS-TiN

Metal Drill Bit HSS-TiN



**NEW**

### D-03888

**€9.20**

Σετ αρίδες κουγκριού SDS-Plus 5 τεμ.

Set of 5 masonry drill bits SDS-Plus

Set includes:

5.5 x 110, 7 x 110, 6 x 160, 7 x 160, 8 x 160 mm



### P-23787

**€11.75**

Σετ αρίδες κουγκριού ELITE 5 τεμ.

Elite Masonry TCT 5pc Set

Set includes:

4, 5, 6, 8, 10mm x 75-120mm



### D-05175

**€5.85**

Σετ αρίδες τούβλου 5 τεμ.

Standard masonry TCT 5pc set

Set includes:

4x70mm, 5x70mm, 6x70mm, 8x110mm, 10x110mm



### D-20719

**€6.05**

Σετ αρίδες κουγκριού 5τμχ

Masonry Drill Bit Set 5pc Set

Set includes:

5x110, 6x110, 7x110, 8x110, 10x110mm



### D-73483

**€15.75**

Σετ αρίδες κουγκριού TCT 12 τεμ.

Set of 12 TCT masonry drill bits

Set includes:

4 / 5 / 5,5 / 6 / 6,5 / 7 / 8 mm

Overall Length

70 / 85 / 100 / 110 mm



### D-74136

**€11.00**

Σετ αρίδες κουγκριού SDS-Plus 4 τεμ.

Set of 4 masonry drill bits SDS-Plus

Set includes:

5x 110 mm, 6x 160 mm, 8x 160 mm, 10x 160 mm

**NEW**



### P-23743

**€8.95**

Σετ Αρίδες Μετάλλου 6 τεμ.

Performance ground point HSS 6pc set

Set includes:

HSS Metal 2, 3, 4, 5, 6, 8mm



### P-23765

**€22.25**

Σετ Αρίδες Μετάλλου 10 τεμ.

Performance ground point HSS 10pc set

Set includes:

HSS Metal 1, 2, 3, 4, 5, 6, 7, 8, 9, 10mm



### D-54081

**€17.45**

Σετ Αρίδες Μετάλλου HSS 19 τεμ.

Performance ground point HSS 19pc set

Set includes:

1/1.5/2/2.5/3/3.5/4/4.5/5/5.5/6/6.5/7/7.5/8/8.5/9/9.5/10mm



### D-54097

**€36.35**

Σετ Αρίδες Μετάλλου 25 τεμ.

Performance ground point HSS 25pc set

Set includes:

1/1.5/2/2.5/3/3.5/4/4.5/5/5.5/6/6.5/7/7.5/8/8.5/9/9.5/10/10.5/11/11.5/12/12.5/13mm



### D-54075

**€9.00**

Σετ Αρίδες Μετάλλου 13 τεμ.

Performance ground point HSS 13pc set

Set includes:

1.5/2/2.5/3/3.2/3.5/4/4.5/4.8/5/5.5/6/6.5mm



### B-67795

**€27.50**

Σετ Αρίδες Μετάλλου 19 τεμ.

Metal Drill Bit HSS-TiN 19pc set

Set includes:

1.5/2/2.5/3/3.2/3.5/4/4.5/5/5.5/6/6.5/7/7.5/8/8.5/10mm



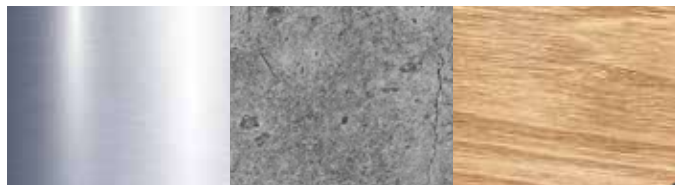

OmnBohrer



**D-30477**

**€9.45**

Σετ αρίδες πολλα. χρήσεων OMNIBOHRER 5 τεμ.

OMNIBOHRER 5pc set 5-12mm

Set includes:

5x85, 8x110, 12x150, 6x100, 10x150 mm



**D-71962**

**€11.70**

Σετ Αρίδες 9 τεμ.

9pc Mixed Drill Set

Set includes:

HSS Metal 5, 6, 8mm  
Wood 5, 6, 8mm  
Masonry 5, 6, 8mm

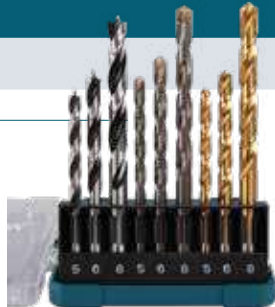

**D-47173**

**€23.50**

Σετ Αρίδες 18 τεμ.

18pc Mixed Drill Set

Set includes:

HSS Metal 4, 5, 6, 7, 8, 10mm  
Wood 4, 5, 6, 7, 8, 10mm  
Masonry 4, 5, 6, 7, 8, 10mm



**E-10883**

**€222.00**

Σετ Αξεσουάρ Πλαστική Τσάντα 221τεμ.

221 pc Maintenance tool set 221 pcs

90x 25 mm bits 1/4" form C: various sizes and fits	2x Extension 1/4"
30x 30 mm bits 5/16" form C: various sizes and fits	2x Extension 1/2"
20x Tor x bits 1/4": various sizes and fits	2x Spark plug wrench 1/2": SW 16/21 mm
1x Screwdriver with magnetic bit holder	1x Adapter for sockets 1/4"
1x Screwdriver for bits and sockets	1x Adapter 1/2" x 5/16"
2x Bit adapters: 1 x 1/4" and 1 x 1/2"	1x Adapter 1/2" x 3/8"
11x Combination spanners: 8-19 mm	1x Universal joint 1 / 4"
8x Allen keys: 1.5, 2, 2.5, 3, 4, 5, 6, 8 mm	1x Universal joint 1/2"
1x Ratchet 1/4" 72 teeth	1x Adapter for extension 1/2"
1x Ratchet 1/2" 72 teeth	1x T-handle for sliding piece 1/4"
13x Sockets 1/2": SW 4-14 mm	
11x Sockets 1/2": SW 15-32 mm	
12x Sockets 1/4" form E: SW 5-13 mm	
7x Tor x socket bits 1/2"	

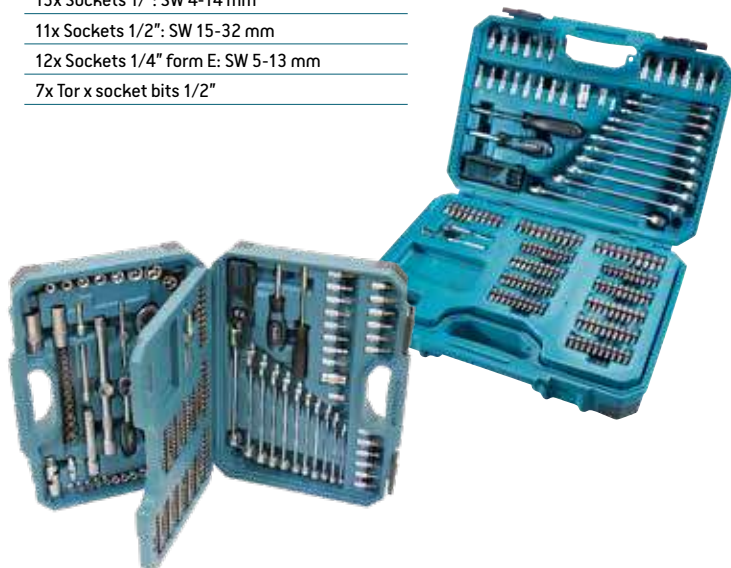

**B-43044**

**€124.00**

Σετ Αξεσουάρ σε Μακpac 1 66τεμ.

66pc Μακpac 1 Drill & Screw Bit set

Supplied in a type 1 Μακpac case

5x HSS bits

5x Wood bits

3x Wood flat Bits

11x Torx bits

7x ST bits

3x Slotted bits

5x Phillips bits

5x Pozzi bits

4x Hex bits

5x Magnetic Nut setters

1x 10 piece bit set  
in a flip top case

1x Magnetic bit holder

1x 1/4" Hex Shank  
quick change chuck



**D-58877**

**€35.00**

Σετ Αξεσουάρ Πλαστική Κασετίνα 42τεμ.

42pc drill & screw bit set

Shank - 1/4" Hex

Screw Bits - 3x Slotted, 4x Phillips,  
5x Pozzi, 8x Torx & 4x Hex

Nutsetter - 5, 6, 7, 8, 10, 11 &  
13mm x 38mm length

Metal Drill Bit - 2.5 x 75mm, 3.0 x 80mm, 4.0 x  
95mm, 5.0 x 105mm & 6.0 x 110mm

Magnetic Bit Holder

1/4" Socket Adaptor

Bit Holder



**B-36170-10**

**€37.80**

Σετ κασάνια 47τεμ

47pc ratchet & bit set

PH1(2x), PH2(2x), PH3(2x)

PZ1(2x), PZ2(2x), PZ3(2x)

T10(2x), T15(2x), T20(2x), T25(2x), T30(2x),  
T40(2x)

SL4.5(2x), SL5.5(2x), SL6.5(2x)

H2, H2.5, H3, H4, H5, H6 Sockets 5, 6, 7, 8, 9,  
10, 11mm

Screwdriver handle 1/4"

Hex shank Magnetic holder



**E-11829**

**€35.00**

Σετ Αξεσουάρ Πλαστική Κασετίνα 60τεμ. "Pro"

60pc Drill & Screw Bit 'Pro' Set

32x 25mm Screwdriver bits

1x Drywall Bit C-form 30mm

1x Magnetic Bit Holder

7x Nut Setters

1x Countersink 6x Wood Drill bits

7x HSS-TiN Metal Drill bits

5x Masonry Drill bits



**P-52065**

**€85.00**

Σετ Αξεσουάρ Ρούχιν Τσάντα 79τεμ.

79pc technician's pouch

Αυτό το σετ περιλαμβάνει μύτες κατασβιδιού  
μεγάλου μήκους ή ευκολότερη πρόσβαση  
σε βίδες βαθιάς τοποθέτησης. Περιλαμβάνει  
επίσης αριθμοί HSS και Τοιχοποιίας για γενικές  
εφαρμογές.

1x 120mm(L) Clear Screw Guide

2x Screw Finders

7x Hex Shank HSS Drill, Titanium Coated

5x Hex Shank Masonry Drill

5x Hex Shank Flat Bits

8 x 1/4" Dr 6pt Socket

19 x 25mm Screwdriver Bits

2 x Bit Adapters

1 x 1/4" Dr Universal Joint

1 x 1/4" Dr Ratchet Handle

10 x 50mm Screwdriver Bits



**B-49638**

**€109.00**

Σετ Αξεσουάρ σε Μακpac 1 69τεμ.

69pc Μακpac 1 Drill & Screw Bit set

Supplied in a type 1 Μακpac case

HSS-G Metal Drill Bits: 3/4/5/6/8

Wood Drill Bits: 3/4/5/6/8

Masonry Drill Bits: 5.5/6/7/8

25mm Screwdriver Bits:  
PZ0/PZ1/PZ2/PZ3/PH0/PH1/PH2/PH2/  
PH3/T10/T15/T15/T20/T25/T25/T27/  
T30/T30/SL0.5X4/SL0.6X4.5/SL1.0X5.5/  
SL1.0X6.5/ST10/ST15/ST20/ST25/ST27/  
ST30/ST40/Hex3/Hex4/Hex5/Hex6

50mm Screwdriver Bits:

PZ2 x 5/PH2 x 5 in flip top case

Quick Change 1/4" Hex Shank Magnetic Bit Holder



**E-10899****€129.00**

Σετ Εργαλεία Χεριού 76τεμ.

76pc Hand Tool set

**E-11542****€239.00**

Σετ Εργαλεία Χεριού σε Μακρας 1 87τεμ.

87pc Μακρας 1 Hand Tool set

**E-06270****€122,00**

Σετ Αξεσουάρ Πλαστική Κασετίνα 212τεμ.

212pc drill and screw bit set

Ένα εκτενώς εξοπλισμένο σετ αριθμών 212 τεμαχίων. Για διάτρηση σε ξύλο, πέτρα και μέταλλο. Τακτοποιημένα σε μια εύχρηστη θήκη μεταφοράς.

44 HSS-R Drill Bits – 1 x 5, 1.5 x 5, 2 x 5, 2.5 x 4, 3 x 5, 3.2 x 2, 3.5 x 4, 4 x 4, 4.5, 5, 5.5, 6, 6.5, 7, 7.5, 8, 9, 10

13 Masonry Drill Bits – 3, 4, 4.5, 5, 5.5, 6, 6.5, 7, 8, 9, 10 x 120mm & 8, 10 x 300mm

8 Wood Drill Bits, Half Ground – 3, 4, 5, 6, 7, 8, 9, 10

6 1/4" Hex Shank Flat Bits – 12, 16, 18, 20, 22, 25

60 Screw Bits C-Form – PH0 x 2, PH1 x 2, PH2 x 6, PH3 x 2, PH4 x 1, PZ0 x 2, PZ1 x 2, PZ2 x 4, PZ3 x 2, SL0.5X3 x 2, SL0.8X4 x 2, SL0.8X5 x 2, SL1X5.5 x 2, SL1X6 x 2, SL1.2X7 x 2, SL1.6X8 x 2, HEX3, HEX4, HEX5, HEX6, HEX7, HEX8, T10 x 2, T15 x 2, T20 x 2, T25 x 2, T27, T30 x 2, T35, T40, T45, SQ1, SQ2, SQ3

40 Screw Bits E-Form – PH0 x 2, PH1 x 2, PH2 x 3, PH3 x 2, PZ0, PZ1 x 2, PZ2 x 2, PZ3 x 2, T10, T15, T20, T25, T27, T30, T40, T45, SL0.5X3 x 2, SL0.8X4 x 2, SL0.8X5 x 2, SL1X6 x 2, SL1.2X7, SL1.6X8, HEX3, HEX4, HEX5, HEX6, HEX7, HEX8

20 Nut Setters – 5, 5.5, 6, 7, 8, 9, 10, 11, 12, 13, 5/32, 3/16, 7/32, 1/4, 9/32, 5/16, 11/32, 3/8, 7/16, 1/2

Counter Sink 12.7

Magnetic Bit Holder

4 Depth Stops – 3, 5, 8, 10

Hex Wrench for Depth Stop

Diameter Gauge

4 Hole Saws – 32, 38, 44, 54

Arbour for Hole Saw

Tape Measure 3m

Spirit Level

T-shaped screwdriver handle magnetic tip

2 Centre Punch – 1.5, 2.5mm

Pencil

Flexible bit holder

Screw driver for C-Form

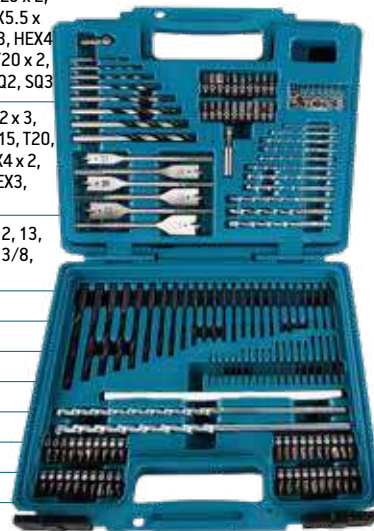
**B-68432****€48.50**

Σετ Αξεσουάρ Πλαστική Κασετίνα 102τεμ.

102pc drill and screw bit set

Περιέχει μια μεγάλη γκάμα αριθμών για ξύλο, πέτρα και μέταλλο σε μήκη 25mm και 50mm  
Includes socket wrench inserts, bit holders, drywall bits, depth limiter and a countersink

HSS-Tin Drill Bit - 1x34mm, 1.5x40mm, 2x49mm, 2.5x57, 3x61mm, 3.5x70mm, 4x75mm, 4.5x80mm, 5x86mm, 5.5x93mm, 6x93mm, 6.5x101, 7x109mm

Masonry Drill Bit - 3x60mm, 4x75mm, 5x85mm, 5.5x85mm, 6x100mm, 6.5x100mm, 7x100mm, 8x120mm, 9x120mm, 10x120mm

Wood Drill Bit - 3x60mm, 4x75mm, 5x85mm, 6x92mm, 8x114mm, 10x120mm

Countersink Bit - 36mm; 25mm

Screwdriver Bit - PH1, PH2, PH3, PZ1 x 2, PZ2 x 3, PZ3 x 2, T10, T15, T20, T25, T27, T30, HEX3, HEX4, HEX5, HEX6, SL0.5X3 x 2, SL0.5X4 x 2, SL0.6X4.5 x 2, SL1.0X6 x 2, SL1.2X7, SL1.2X8

Dry Wall Screw Bit - 30mm x 2

Magnetic Bit Holder - 60mm

50mm Screwdriver Bit - PH1, PH2, PH3, PZ1, PZ2, PZ3, T10, T15, T20, T25, T30, T40, HEX3, HEX4, HEX5, HEX6, SL0.5X4, SL0.6X4.5, SL1.2X7Y, SL1.2X8

38mm Nutsetter 1/4", 9/32" 5/16", 11/32", 3/8", 7/16", 1/2", 6.0, 7.0, 8.0, 9.0, 10.0, 11.0, 12.0

Depth Stop 3.0, 5.0, 8.0

Diameter Gauge

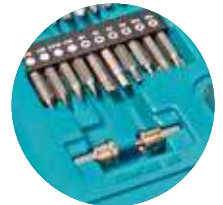
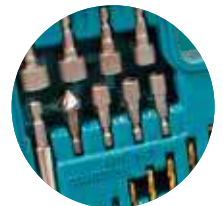
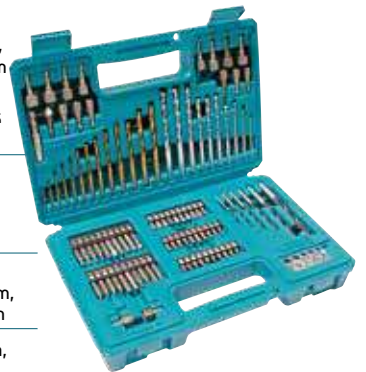

**P-79142**

**€25.20**

Σετ κασάνια 1/4 με 10 μύτες

Screwdriver+1/4" bit set

1x Socket 1/4" driver

1x 1/4" magnetic bit holder Length: 25mm



**B-65551**

**€33.00**

Σετ Ποθύγωνα 8-19mm 5 Τεμ.

Double box spanner 5pcs. set

8 x 9, 10 x 11, 12 x 13, 14 x 15, 18 x 19 mm



**B-65545**

**€24.50**

Σετ Ποθύγωνα κοφτά 8-18mm 5 Τεμ.

Flare Nut Wrench 5pcs Set

9 x 11, 10 x 12, 13 x 14, 15 x 17, 16 x 18 mm



**B-65894**

**€11.85**

Σετ Αθήεν μπίθια 9τεμ.

Hex key wrench 9pcs. Set

1.5, 2, 2.5, 3, 4, 5, 6, 8, 10mm



**B-65539**

**€45.00**

Σετ Σχιστοποθύγωνα 9τεμ. 8-18mm

Combination spanner 9pc set

8, 10, 12, 13, 14, 15, 16, 17, 18 mm



**E-11558**

1/4'

**€23.00**

**E-11564**

3/8'

**€29.50**

**E-11570**

1/2'

**€37.50**

Κασάνια

Drive ratchet handle 84Teeth



# LOCKING ADJUSTABLE WRENCH



B-65470

**B-65414** 6" 150mm €13.95

**B-65470** Με κλείδωμα 12" 300mm €48.60

Σουηδικά

Adjustable wrenches



**B-65486** 10" 250mm €27.00

**B-65492** 12" 300mm €36.80

Καουρόπενσες

Box Joint WP pliers



**B-65822** Ίσιο κοντό €23.50

**B-65800** Αριστερό €22.65

**B-65816** Δεξιό €22.65

Ψαλίδια Παμαρίνας

Aviation Snip Cuts



**B-65741** 7" 180mm €37.90

**B-65757** 9,5" 240mm €41.90

**B-65763** 12" 300mm €68.65

Καουρόπενσες

Box Joint WP pliers

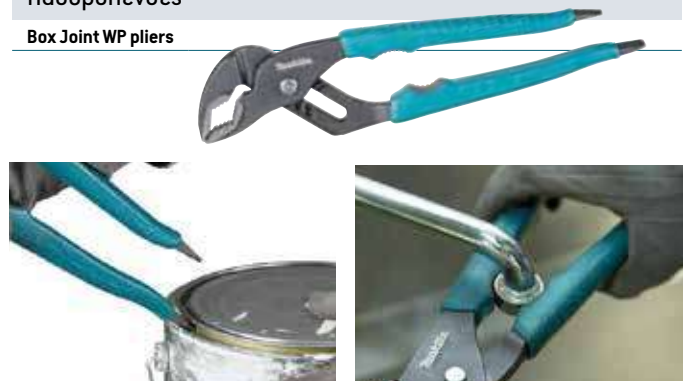



**ANTI-SLIP & OIL  
RESISTANT  
DUAL MATERIAL**

<b>B-66020</b>	4.0x 100mm	<b>€3.65</b>
<b>B-66036</b>	5.5 x 100mm	<b>€4.75</b>
<b>B-66042</b>	6.5 x 125mm	<b>€5.80</b>
<b>B-66058</b>	8.0 x 150mm	<b>€7.95</b>

Κατσαβίδια Ίσια

Straight Screwdrivers



<b>B-65975</b>	T10X100mm	<b>€5.00</b>
<b>B-65981</b>	T15X100mm	<b>€5.00</b>
<b>B-65997</b>	T20X100mm	<b>€5.00</b>
<b>B-66008</b>	T25X100mm	<b>€5.80</b>
<b>B-66014</b>	T30X100mm	<b>€5.80</b>

Κατσαβίδια Αστεράκι TORX

Screwdrivers TORX



<b>B-65903</b>	PH1 x 100mm	<b>€4.75</b>
<b>B-65919</b>	PH2 x 100mm	<b>€5.80</b>
<b>B-65931</b>	PH3 x 100mm	<b>€8.00</b>
<b>B-65947</b>	PZ1 x 80mm	<b>€4.55</b>
<b>B-65953</b>	PZ2 x 100mm	<b>€5.80</b>
<b>B-65969</b>	PZ3 x 150mm	<b>€8.00</b>

Κατσαβίδι Σταυρωτό

Cross Screwdrivers



<b>B-66064</b>	PH1 x 75mm	<b>€5.65</b>
<b>B-66070</b>	PH2 x 100mm	<b>€6.65</b>
<b>B-66086</b>	PH3 x 150mm	<b>€9.25</b>
<b>B-66092</b>	PZ1 x 75mm	<b>€5.65</b>
<b>B-66101</b>	PZ2 x 100mm	<b>€6.65</b>
<b>B-66117</b>	PZ3 x 150mm	<b>€9.10</b>

Κατσαβίδια σταυρωτά HEX-GEAR

Go Through Screwdrivers



<b>B-42438</b>	12° PH2 X 125	<b>€21.00</b>
<b>B-42444</b>	12° PH3 X 150	<b>€23.00</b>
<b>B-42450</b>	12° PZ2 X 125	<b>€21.00</b>
<b>B-42466</b>	12° PZ3 Z 150	<b>€23.00</b>

Κατσαβίδια χτυπητά περιστρεφόμενα

Shock Drivers



## Recipro Blades

**B-10637**

**€19.00**

Λεπίδες Recipro αεριζόμενο σκυρόδεμα 305mm

Aerated concrete Recipro blades 305mm

Set includes:3



**B-13677**

**€11.40**

Σετ λεπίδες Recipro ξύλο/μέταλλο

Set of Recipro blades for wood/metal

Set includes:3



**B-10394**

**€40.60**

Λεπίδα Recipro τούβλου (215mm) 305mm

Recipro blade for brick (215mm) 305mm



**B-10403**

**€57.15**

Λεπίδα Recipro τούβλου (315mm) 400mm

Recipro blade for brick (315mm) 400mm



**B-51312**

**€44.00**

Λεπίδες Recipro S/S (5-125mm) 200mm

Recipro blade S/S (5-125mm) 200mm

Set includes:2



**B-52118**

**€21.80**

Λεπίδες Recipro Fiberglass 225mm

Recipro fiberglass blades 225mm

Set includes:2



**B-52124**

**€31.75**

Λεπίδες Recipro Fiberglass 300mm

Recipro fiberglass blades 300mm

Set includes:2



**B-52130**

**€35.85**

Λεπίδες Recipro Fiberglass 400mm

Recipro fiberglass blade 400mm

Set includes:1



B-10394



## DSD180Z Drywall blades

**B-49703**

**€23.20**

Λεπίδα γυψοσανίδας για DSD180

Drywall blade for DSD180



**B-49719**

**€28.30**

Λεπίδα ξύλου για DSD180

Wood blade for DSD180



## DCO Drywall blades

**191G68-0**

**€13.05**

Σετ 5 αρίδες Ρούτερ Γυψοσανίδας DCO 3.18MM

Set of 5 Drywall Guide Bits for DCO 3.18MM



**191G69-8**

**€3.00**

Αρίδα Ρούτερ Γυψοσανίδας DCO 3.18MM

Drywall Guide Bit for DCO 3.18MM



## Jigsaw Blades

**B-48527**

**€15.60**

Σετ 5 λεπίδες πλαστική θήκη

Set of 5 blades in plastic case

Length: 60 - 77mm

2x B-50, 1x B-51, 1x B-52, 1x B-53



## DBN600ZJ Nailer Finishing Nails



Σπόντες Πιστόλας ακέφαλες / Nail 16GA Brad

Smooth Shank Brads

<b>F-33890</b>	15mm (αTY 2000)	<b>€9.45</b>
<b>F-33906</b>	19mm (αTY 2000)	<b>€10.75</b>
<b>F-33922</b>	25mm (αTY 2000)	<b>€13.05</b>
<b>F-33948</b>	32mm (αTY 2000)	<b>€14.80</b>
<b>F-33964</b>	38mm (αTY 2000)	<b>€16.25</b>
<b>F-33980</b>	45mm (αTY 2000)	<b>€20.20</b>
<b>F-33993</b>	50mm (αTY 2000)	<b>€20.75</b>
<b>F-34027</b>	64mm (αTY 2000)	<b>€29.00</b>

- Made with high-quality steel, with smooth galvanised shanks. The galvanising process reduces the likelihood of rust or staining.
- Using these genuine Makita brad nails ensures the highest performance from the tool, minimising the chances of it jamming.

## DTR180ZK Steel Tie Wire



**199137-9**

**€2.80**

Σύρμα δεσίματος 0.8mm

Steel tie wire 0.8mm



**191J59-9**

**€4.65**

Επικαλυμμένο σύρμα δεσίματος 0.8mm

Coated tie wire 0.8mm



**191A57-9**

**€4.15**

Ηλεκτρογαλβανισμένο σύρμα δεσίματος 0.8mm

Electro-Galvanized Rebar tie wire 0.8mm



## GN420 Concrete Pin & Fuel Cell



**NEW**

Σπόντες Πιστόλας & 1 Φιάλη

<b>196285-5</b>	3,1 x 15mm (αTY 1000)	<b>€100.00</b>
<b>196286-3</b>	3,1 x 17mm (αTY 1000)	<b>€115.75</b>
<b>196287-1</b>	3,1 x 22mm (αTY 1000)	<b>€103.90</b>
<b>196288-9</b>	3,1 x 27mm (αTY 1000)	<b>€103.95</b>
<b>196289-7</b>	3,1 x 32mm (αTY 1000)	<b>€102.40</b>
<b>196290-2</b>	2,6 x 20mm (αTY 1000)	<b>€91.80</b>
<b>196291-0</b>	2,6 x 25mm (αTY 1000)	<b>€92.05</b>
<b>196292-8</b>	2,6 x 30mm (αTY 1000)	<b>€104.35</b>
<b>196293-6</b>	2,6 x 35mm (αTY 1000)	<b>€93.65</b>
<b>196294-4</b>	2,6 x 40mm (αTY 1000)	<b>€119.00</b>



**DURABLE COATING**  
LONG-LASTING  
PERFORMANCE



### DRT50 Router Accessories

**195563-0**

**€93.00**

Plunge base set



**198987-9**

**€42.00**

Router Tilt Base



**195562-2**

**€136.00**

Offset base set



**SMOOTH AND FAST  
CUTTING**



### UT2204 Mixer Accessories

**A-43773**

**€46.00**

Stainless steel shaft for UT2204 - 12mm (shaft only)



**P-22040**

**€40.50**

Steel shaft + propeller for UT2204 - 14mm



**324265-3**

**€21.00**

Shaft holder for UT2204 12mm



**324929-9**

**€21.00**

Shaft holder M14 for UT2204



**A-43717**

**€51.50**

Aluminium mixing blade 220mm for UT2204



### DPB180Z Bandsaw Blades

**792558-0**

**€43.00**

Σετ 3 λεπίδες για το DPB180Z

Set of 3 blades

Diameter 1140 mm

Thickness 13 mm

Teeth per Inch 24



**792559-8**

**€44.25**

Σετ 3 λεπίδες για το DPB180Z

Set of 3 blades

Diameter 1140 mm

Thickness 13 mm

Teeth per Inch 18



# X LOCK QUICK & EFFORTLESS WHEEL CHANGE SYSTEM

**191F81-2**

**€49.00**

Προφυλακτήρας σμυρίδιου συλλογής σκόνης X-LOCK 125mm

Dust collection guard X-LOCK 125mm



191F81-2



**162708-5**

**€11.00**

Κάλυμμα δίσκου 4.1/2" (115mm) X-LOCK

Wheel cover 4.1/2" (115mm) X-LOCK



**347617-1**

**€8.20**

Κάλυμμα δίσκου 5" (125mm) X-LOCK

Wheel cover 5" (125mm) X-LOCK



<b>E-00365</b>	<b>Grinding Wheel</b> 115x6x22,2 X-LOCK (4.1/2") A36P Makita	<b>€2.00</b>
<b>E-00371</b>	<b>Grinding Wheel</b> 115x6x22,2 X-LOCK (4.1/2") WA36N Makita	<b>€2.45</b>
<b>E-00387</b>	<b>Cut-off Wheel</b> 115x3x22,2 mm X-LOCK (4.1/2") A60T Makita	<b>€2.40</b>
<b>E-02060</b>	<b>Diamond Wheel</b> X-LOCK 115mm 4.1/2"	<b>€39.35</b>
<b>E-02076</b>	<b>Diamond Wheel</b> X-LOCK 125mm 5"	<b>€50.95</b>

## Angle Grinder Accessories



**191W05-0**

**€58.70**

Προφυλακτήρας σμυρίδιου συλλογής σκόνης 115/125mm

Dust collection guard 115/125mm



Προστατευτικό κάλυμμα δίσκου σμυρίδιου

Wheel Cover

<b>123098-1</b>	115mm	<b>€9.65</b>
<b>123099-9</b>	125mm	<b>€10.15</b>
<b>122891-0</b>	130mm	<b>€13.70</b>

- For use in grinding applications
- Single screw adjustment; easy installation and removal
- High quality materials for long life

Λαβές Σμυρίδιου

Grip 36 Complete

<b>153489-2</b>	M8	<b>€3.70</b>
<b>152539-0</b>	M12	<b>€6.45</b>



Φλάντζες Σμυρίδιου

Grinder Flanges

<b>224490-5</b>	Inner Flange 45mm	<b>€4.15</b>
<b>224554-5</b>	115mm Lock Nut M14x45mm	<b>€5.40</b>
<b>224543-0</b>	230mm Lock Nut M14x45mm	<b>€5.75</b>
<b>195354-9</b>	180-230mm Toolless Lock Nut M14	<b>€64.00</b>



**D-18764-100**

**€92.90**

Δίσκοι Κοπής μετ. 115mm 100τεμ.

Thin 115mm Cut-Off Wheel 100pc

Diameter	115 mm
Bore	22.23 mm
Pack Quantity	100
Flat Center	✓
Grit	WA60T-BF
Thickness	1.2 mm

**Application:**  
Cutting, aluminium, extrusions, welds, sections, trunking, pipes



<b>B-53687</b>	Διαμαντόδισκος 115mm μέταλλο / PVC / Σκυρόδεμα	<b>€43.80</b>
<b>B-53986</b>	Nebula Διαμαντόδισκος δομικών υλικών Φ115mm 22, 23mm	<b>€18.45</b>
<b>B-53992</b>	Nebula Διαμαντόδισκος δομικών υλικών Φ125mm 22, 23mm	<b>€18.30</b>
<b>B-54025</b>	Nebula Διαμαντόδισκος δομικών υλικών Φ230mm 22, 23mm	<b>€30.00</b>



## 4191DW & CC301 Accessories



**B-21098**

**€39.55**

Διαμαντόδισκος Υγρής Κοπής (Γυαλιού) for 4191DW & CC301

Diamond wheel 85 mm, Wet

- Diameter (D) 85 mm
- Bore Size (Arbor Diameter) 15 mm
- Thickness 1,8 mm
- Segment Height 5 mm



**B-13063**

**€52.90**

Διαμαντόδισκος Ξηράς / Υγρής Κοπής (Κεραμικού) for CC301

Diamond wheel 80 mm, Comet, Dry & Wet

- Diameter (D) 80 mm
- Bore Size (Arbor Diameter) 15 mm
- Thickness 1,6 mm
- Segment Height 5 mm



## DCC500 Accessories



**B-13091**

**€100.00**

Διαμαντόδισκος Ξηράς / Υγρής Κοπής (Κεραμικού) for DCC500

Diamond wheel 125 mm, Comet, Dry & Wet

- Diameter (D) 125 mm
- Bore Size (Arbor Diameter) 20 mm



**B-12778**

**€65.00**

Διαμαντόδισκος Ξηράς / Υγρής Κοπής (Κεραμικού) for CC301

Diamond wheel 125 mm, Comet Rapide, Dry & Wet

- Diameter (D) 125 mm
- Bore Size (Arbor Diameter) 20 mm



**198948-9**

**€35.00**

Διαμαντόδισκος Ξηράς Κοπής (Τσιμέντο) for CC301

Diamond wheel 125 mm, Concrete, Dry

- Diameter (D) 125 mm
- Bore Size (Arbor Diameter) 20 mm



**B-21951**

**€44.30**

Διαμαντόδισκος Υγρής Κοπής (Τσιμέντο) for CC301

Diamond wheel 125 mm, Concrete, Wet

- Diameter (D) 125 mm
- Bore Size (Arbor Diameter) 20 mm



**191X01-4**

**€51.00**

Παροχή νερού for CC301

Water Supply Cover Set A



## SDS MAX Accessories

**B-13976**

**€117.20**

Φτυάρι SDS-MAX 135x400mm

Clay Spade SDS-MAX, 135 x 400 mm



**B-14021**

**€36.00**

Ξύστρα Πλακιδίων SDS-MAX 50 X 300mm

Tile Chisel SDS-MAX 50 x 300 mm



**P-54156**

**€295.00**

Ξύστρα Δαπέδου SDS-MAX 150X635mm

Floor Scraper SDS-MAX 150 x 635 mm



**NEW**

**P-53914**

**€230.00**

Ταχυσύνδεσμος υποδοχής SDS-MAX

Connector SDS-MAX, 30 x 190 mm



Προέκταση για υποδοχή SDS-MAX

Connector SDS-MAX

**NEW**

**P-53920**

320mm

**€35.45**

**P-53936**

750mm

**€46.90**

**P-53942**

100mm

**€66.50**



## Heat gun Accessories

**P-71417**

**€8.40**

Glass Protection Nozzle 58 x 35mm



**P-71423**

**€8.60**

Wide Slot Nozzle, 58 x 35 mm



**P-71439**

**€8.40**

Reduction Nozzle, 41 x 35 mm



**P-71445**

**€8.60**

Reflection Nozzle, 58 x 35 mm



**PR0000035**

**€10.00**

Pressure roller, 30 mm



## Rotary Hammers SDS-Plus Accessories

**P-54162**

**€105.00**

Λεπίδα Ξύστρας Δαπέδου

Blades for Floor Scraper



**A-68161**

**€112.00**

Ξύστρα Πλακιδίων SDS-PLUS 100 X 160mm

Scraper Chisel Sds-Plus 100x 160mm



## DTW Impact Wrench Accessories

**B-68448**

**€15.70**

Αντάπτορας παλμικού βιδολόγου από 1/2" - 1/4"

Bit adapter, 51 mm



**134873-0**

**NEW**

Προσαρμογέας παλμικού βιδολόγου 1/2" - 1/4"

Bit adapter, 1/2" - 1/4"



## DMP180 Accessories

**TE0000691**

**€23.95**

Προέκταση βαλβίδας λαστικού αέρα 30°

Air Valve Adapter 30 Degree Head



**TE0000796**

**€29.00**

Προέκταση βαλβίδας λαστικού αέρα 0°

Air Valve Adapter Head 0°



## DFR Extension handle

**194500-1**

**€90.00**

Λαβή επέκτασης 890-990mm

Extension handle 890 - 990 mm



## TR001G Extension handle

**1915N6-8**

**€251.00**

Λαβή επέκτασης

Extension handle



## DSL800 Drywall Pole Sander Extension Handle

**199937-7**

**€205.35**

Λαβή προέκτασης τριβείου γυψοσανίδας για DSL800



## DFS-FS Drywall screwdriver Accessories

**191L24-0**

**€133.40**

Εξάρτημα αυτόματης τροφοδοσίας, 25-55 mm

Autofeed Attachment, 25-55 mm

- Capacity Drywall Screw 3,5 - 4,0 mm
- Collated drywall screw 25 - 55 mm

Βίδες γυψοσανίδας μαύρες

Drywall Screws Black

**F-30913** 3,9x25 (ατυ 1000) **€38.30**

**F-31153** 3,9x35 (ατυ 1000) **€40.00**

**F-31182** 3,9x41 (ατυ 1000) **€40.00**

**F-31140** 3,9x55 (ατυ 1000) **€40.00**

**F-31195** 3,9x95 (ατυ 1000) **€30.00**

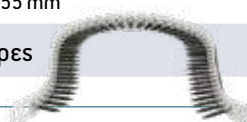

## Chuck Adaptors



**194250-8**

**€47.00**

Adaptor Chuck - 1/4 Hex Keyless Chuck



**194041-7**

**€24.55**

Drill Chuck for SDS-Plus



**D-14093**

**€2.55**

SDS-PLUS to rotary adaptor



## Planner Blades



**D-07945**

**€13.20**

TCT Blade 82mm MINI (2pcs)

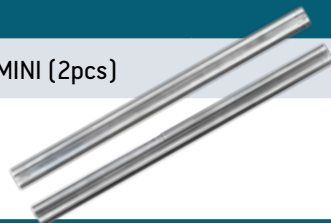

**D-16346**

**€9.00**

HSS Blade 82mm (2pcs) Reusable



## Router Bit Adaptors



### Μεταπτώσεις

#### Chuck Sleeves

<b>763801-4</b>	6mm (12x6)	<b>€8.00</b>
<b>763804-8</b>	8mm (12x8)	<b>€7.30</b>
<b>763807-2</b>	12mm (12x10)	<b>€5.70</b>
<b>763808-0</b>	1/2"x1/4"	<b>€8.50</b>
<b>763803-0</b>	12"x1/4"	<b>€7.35</b>
<b>763805-6</b>	1/2"x3/8"	<b>€7.50</b>

## Collet Cones



### Κώνικα

#### Collet Cones

<b>763607-0</b>	6mm M3700		<b>€7.55</b>
<b>763608-8</b>	1/4" M3700		<b>€6.55</b>
<b>763618-5</b>	8mm RT0700-M3601		<b>€3.55</b>
<b>763619-3</b>	3/8" RT0700-M3601		<b>€5.80</b>
<b>763636-3</b>	6mm RT0700-M3601		<b>€15.00</b>
<b>763637-1</b>	1/4" RT0700-M3601		<b>€12.90</b>
<b>763622-4</b>	1/2" PR2301-M3600		<b>€19.50</b>
<b>763628-2</b>	12mm PR2301-M3600		<b>€17.70</b>

## DHR243 Dust extraction system

199570-5

€154.00

DX07 Σύστημα εξαγωγής σκόνης

Dust collection guard 115/125mm

- Filter cleaning mechanism
- Large dust box cover
- Adjustable Depth Stop
- HEPA Filtration System - the filter captures 99.97% of particulates .3 microns and larger



## DHR182 Dust extraction system **NEW**

199664-6

€159.00

Σύστημα εξαγωγής σκόνης



## Dust Collecting Cap

195179-1

€10.30

Σύστημα αναρρόφησης σκόνης

Dust Collecting Cap

Suitable for models:

- HR2630T • HR3012FC



## Dust Collecting Cap for angle grinders

196845-3

€112.25

Προφυλακτήρας αναρρόφησης για κοπή 125 mm

Dust collecting cover 125 mm

Diameter: 32/37 mm



198440-5

€178.00

Προφυλακτήρας αναρρόφησης για κοπή 230 mm

Dust collecting cover 230 mm

Diameter: 32/37 mm



## UB1103 Blower Accessories

123245-4

€7.45

Blower nozzle for UB1103 /DUB185

- Only to be used with adapter 197853-7
- Sewer/pipe unblocking hose



123241-2

€11.50

Dustbag for UB1103 /DUB185



## DCG180ZBK Holder

196351-8

€50.55

300ml Holder



1911T4-0

€123.00

600ml Holder



**NEW**

## Saw Stands

DEAWST05

€374.00

Βάση πριονιού / Γενική χρήση

Saw Stand / General Use

- Compatible with all slide compound saws mitre saws, and table top mitre saws
- Two adjustable working heights 55cm/80cm
- Folds flat for easy storage and transport without disassembling the machine



DEBWST06

€276.00

Βάση πριονιού

Mitre Saw Stand

- L: 1,150mm/2,550mm
- W:750mm H:850mm
- Maximum extended width of up to 2550mm wide
- Easy tool-less installation and removal of the mitre saw



194043-3

€138.25

Βάθρο για δισκοπρίνο

Stand for slide compound saws

- Foldable for easy transportation and storage



### Hammer Drill Maintenance

**1914C5-7**

**€6.35**

Γράσο 30g

Hammer Grease 30g

- Suitable for use with SDS-Plus and SDS-Max Hammer Drills
- Prolongs the tool's service life



**198993-4**

**€13.15**

Γράσο 100ml

Hammer Bit Grease 100ml

- Designed to keep the shank of the bit lubricated for more efficient results.



### Hammer Drill Maintenance KIT

KIT Συντήρησης

Maintenance KIT



**195103-4**

HM1317C

**€25.20**

**195113-1**

HM0870C

**€43.00**

**195114-9**

HM1203

**€51.00**

**195263-2**

HR2470

**€15.45**

**196532-4**

HR4013C

**€41.50**

**196968-7**

HR2630

**€14.00**

### DVP180 Vacuum Pump Oil 150ml



**AS00VP050M**

**€12.85**

Λάδι αντλίας ψυκτικού 150ml

Vacuum Pump Oil 150ml



### DHW080ZK Power Washer Accessories



**197837-5**

**€35.00**

Pipe Cleaning Hose 10m

- Only to be used with adapter 197853-7
- Sewer/pipe unblocking hose



**197853-7**

**€7.95**

Accessory Joint Set / Αξεσουάρ Σύνδεσης Λαστίχου



### DCU180Z Wheelbarrow Accessories

**199009-8**

**€308.00**

Pipe frame set

- Adjustable Frame Size:  
Min.: 850x660mm /  
Max: 1.095x980mm



**199008-0**

**€234.00**

Bucket set

- Capacity: 90 lt
- Size: 1.310 mm



SEE PAGE 80

**NEW**  
NEO

**Makita**<sup>®</sup>

**COMBO  
DEALS**



0 1 2 3 4 5 6 7

0 1 2

# GUIDE RAIL SYSTEM

PRECISION CUTTING,  
ROUTERING & TRIMMING  
SOLUTIONS



# GUIDE RAIL SYSTEM

PRECISION CUTTING,  
ROUTERING & TRIMMING  
SOLUTIONS

<b>199140-0</b>	100cm	<b>€54.50</b>
<b>194368-5</b>	140cm	<b>€62.00</b>
<b>199141-8</b>	150cm	<b>€71.00</b>
<b>194925-9</b>	190cm	<b>€82.00</b>
<b>194367-7</b>	300cm	<b>€261.00</b>

Ράγες - Οδηγοί Εργαλείων

Guide Rails

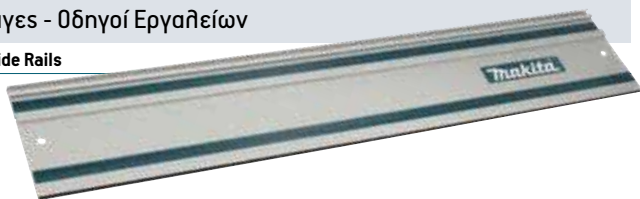

**19885-7**

Guide Rail Connector Set

Connects two lengths  
of Guide Rails



**423362-3**

Replacement Glide Strip 3m

Αντιολισθητική Ταινία Ράγας 3m



**194385-5**

Clamp Set

Secures rail to material



**€39.50**

**1913K5-7**

Extrusion Clamps

Σφιχτήρας ράγας Clamp for Guide rail



**€49.00**

**199826-6**

Quick-Release Ratcheting Guide Rail Clamp Set (2pcs)

Σφιχτήρες ράγας  
ταχείας απεθ/σης (2τμχ)



**€117.00**

**196664-7**

Bevel Guide

For quick and accurate  
bevel cuts



**€48.90**



- Το σύστημα καθοδήγησης-ράγες επιτρέπει ακριβείς λύσεις κοπής (cutting-routing-trimming), για σωστή και μέγιστη ακρίβεια.
- Εύκολη συναρμολόγηση και εγκατάσταση που σας εξοικονομεί χρόνο και χρήμα.
- Ο σχεδιασμός του συστήματος επιτρέπει τη μέγιστη ευελιξία σε διάφορες εφαρμογές και υλικά.

## OPTIONAL ACCESSORIES / ADAPTERS



No adaptor Required

**194579-2**

**197252-3**

For Model:  
SP6000

For Model:  
CA5000X

For Models:  
3612C, RP0900K, RP1801F,  
RP2301FC, RT0701C

For Model:  
DHS680

**€51.50**

**€95.10**



**192506-3**

**195838-7**

**193517-1**

**197005-0**

For Model:  
5903

For Model:  
DHS630

For Models:  
4329K, 4350FCT, 4351FCT, DJV180,  
DJV181, DJV182, JV0600K, VJ01

For Model:  
HS7601J

**€183.00**

**€52.00**

**€32.00**

**€65.50**



**197462-2**

**199232-5**

**196953-0**

For Model:  
HS6600, HS6601

For Model:  
DHS660/661

For Models:  
XSH03

**€38.00**

**€61.00**

**€61.00**



**SP6000**

**CA5000X**

**RP2301FC**

**4350FCT**

**Υπηρεσία Επισκευής & Ανταλλακτικά.**

***Mak*service**

Με ένα μεγάλο δίκτυο εγκεκριμένων συνεργατών παγκύπρια  
(Makita Service Points), όπου μπορείτε να εξυπηρετηθείτε άμεσα.

Αποστολή μας, είναι η γρήγορη και ασφαλής επιδιόρθωση του εργαλείου σας.

**Μαζί σας και μετά την αγορά!**

Δωρεάν γραμμή εισηγήσεων/παραπόνων: 80041000



**Makita**<sup>®</sup>

# SPECIAL TOOLS

**DTC100ZK** ΜΟΝΟ ΜΕ ΠΑΡΑΓΓΕΛΙΑ ORDER ONLY €1808.00

Κόφτης Καλωδίων κλειστού τύπου 50mm  
Cable Cutter 50mm - Closed Type

**DTC102ZK** ΜΟΝΟ ΜΕ ΠΑΡΑΓΓΕΛΙΑ ORDER ONLY €2245.00

Κόφτης Καλωδίων κλειστού τύπου 65mm  
Cable Cutter 65mm - Closed Type

Dimensions	116 x 197 x 363 mm
Net Weight	2.22 kg (without battery)

- For cutting Al / Cu cable
- Automatic Reverse Function - The movable blade automatically returns to the set position after the cutting is completed
- Adjustable Blade Return Volume - The blade opening angle can be adjusted to suit the diameter of the cable to be cut
- One LED job light with afterglow function

**LITHIUM-ION LXT**

Συμπεριλαμβάνει θήκη μεταφοράς. Δεν συμπεριλαμβάνει μπαταρία και φορτιστή.



**DTC101ZK** ΜΟΝΟ ΜΕ ΠΑΡΑΓΓΕΛΙΑ ORDER ONLY €2129.00

Κόφτης Καλωδίων ανοικτού τύπου 50mm  
Cable Cutter 50mm - Open Type

Max Blade Opening Width	50 mm
Dimensions	116 x 197 x 363 mm
Net Weight	3.60 kg (without battery)

- For cutting Al / Cu cable
- Automatic Reverse Function - The movable blade automatically returns to the set position after the cutting is completed
- Adjustable Blade Return Volume - The blade opening angle can be adjusted to suit the diameter of the cable to be cut
- One LED job light with afterglow function

**LITHIUM-ION LXT**

Συμπεριλαμβάνει θήκη μεταφοράς. Δεν συμπεριλαμβάνει μπαταρία και φορτιστή.



**DTC103ZK** ΜΟΝΟ ΜΕ ΠΑΡΑΓΓΕΛΙΑ ORDER ONLY €3855.00

Κόφτης Καλωδίων ACSR 60mm  
Cable Cutter ACSR 60mm

Max Blade Opening Width	54 mm
Dimensions	6 x 240 x 401 mm
Net Weight	4.80 kg (without battery)

- For cutting Aluminum Conductors Steel Reinforced (ACSR)
- Automatic Reverse Function - The movable blade automatically returns to the set position after the cutting is completed
- Adjustable Blade Return Volume - The blade opening angle can be adjusted to suit the diameter of the cable to be cut
- One LED job light with afterglow function

**LITHIUM-ION LXT**

Συμπεριλαμβάνει θήκη μεταφοράς. Δεν συμπεριλαμβάνει μπαταρία και φορτιστή.





## DTC104ZK

ΜΟΝΟ ΜΕ ΠΑΡΑΓΓΕΛΙΑ  
ORDER ONLY

€7849.00

### Κόφτης Καλωδίων 105mm

#### Cable Cutter 105mm

Max Blade Opening Width	105mm
Dimensions	718 x 123 x 267 mm
Net Weight	9.8Kg

- Output force 120kN For heavy-duty applications
- TRIGGER LOCK FUNCTION closes the blades to perform the cutting operation
- Automatic Reverse Function: After cutting, the motor stops and the blade auto-reverses to its original position
- Release Button: Opens the blades to maximum opening angle manually
- One LED job light with afterglow function

**LITHIUM-ION LXT**

Συμπεριλαμβάνει  
θήκη μεταφοράς.  
Δεν συμπεριλαμβάνει  
μπαταρία και φορτιστή.



## DTC301ZK

ΜΟΝΟ ΜΕ ΠΑΡΑΓΓΕΛΙΑ  
ORDER ONLY

€4296.00

### Υδραυλική Πρέσα Ακροδεκτών 31mm

#### Crimper 31mm

## DTC302ZK

ΜΟΝΟ ΜΕ ΠΑΡΑΓΓΕΛΙΑ  
ORDER ONLY

€4318.00

### Υδραυλική Πρέσα Ακροδεκτών 42mm

#### Crimper 42mm

Dimensions	437 x 94 x 349 mm
Net Weight	7.2 kg (without battery)

- HEAVY DUTY CRIMPER engineered for professionals crimping terminals onto large-diameter electric wires
- IMPRESSIVE CRIMPING CAPACITY - Copper: up to 22.5mm (400mm<sup>2</sup>) / Aluminium: Up to 19.5mm (300mm<sup>2</sup>)
- 42MM C-SHAPED JAW opens wide, making it easier and faster to insert connectors
- AUTO RETRACT FUNCTION - Hydraulic crimper allows ram automatically to retract to its original position after crimping, enhancing efficiency (for pull back the ram manually press the release knob)
- The On/Off setting of the auto retract function can be switched by turning the screw provided on the machine
- CRIMPING HEAD - The head rotates 270 degrees, making it easy to use in a various positions
- ERGONOMIC HANDLE Reduces hand fatigue, improves control during prolonged use
- LED job light : Single LED with afterglow function

**LITHIUM-ION LXT**

Συμπεριλαμβάνει  
θήκη μεταφοράς.  
Δεν συμπεριλαμβάνει  
μπαταρία και φορτιστή.



## DHK180Z



€674.00

18V Brushless SDS+ Ξύστρα

Brushless SDS Plus Power Scraper 18v

Blows per minute	0 - 3,200 bpm
Impact energy	3.1 Joules
Net Weight	3.5kg
Overall length	368 mm



Δεν συμπεριλαμβάνει μπαταρία και φορτιστή  
Does not include battery and charger

**BL MOTOR LITHIUM-ION LXT XPT AVT**

## DHR20Z



€188.00

18V SDS+ Κρουστικό περιστροφικό τράπανο 20mm

SDS-Plus cordless rotary hammer 20mm 18v

Optimum Drilling	4 - 12 mm
Capacity Concrete	20 mm
Capacity Steel	13 mm
Capacity Wood	26 mm
Blows per minute	0-4000 bpm
Impact energy	2.0 Joules
Net Weight	3.2kg
No Load Speed	0 - 1100 rpm



Δεν συμπεριλαμβάνει μπαταρία και φορτιστή  
Does not include battery and charger

**LITHIUM-ION LXT**

## HR166DZ



€235.00

12V Κρουστικό περιστροφικό τράπανο 16mm

Rotary hammer 16mm 12v

Optimum Drilling	4 - 8 mm
Capacity Concrete	16 mm
Capacity Steel	10 mm
Capacity Wood	13 mm
Impact rate	0-4800ipm
Impact energy	1.1 Joules
Net Weight	2.0kg
No Load Speed	0 - 680 rpm



Δεν συμπεριλαμβάνει μπαταρία και φορτιστή  
Does not include battery and charger

**BL MOTOR LITHIUM-ION 12Vmax CXT**

## Rotary Hammers SDS-Plus Scrapers & Blades

Find in **accessories** section



### DHK180Z

This cordless scraper accepts SDS Plus bits and provides total mobility to concrete scraping, chiseling, scaling, and light-duty breaking applications.



## DHR171Z



€249.50

18V SDS+ Κρουστικό περιστροφικό τράπανο 17mm

SDS-Plus rotary hammer 17mm 18v

Optimum Drilling	4 - 10 mm
Capacity Concrete	17 mm
Capacity Steel	10 mm
Capacity Wood	13 mm
Impact rate	0-4800ipm
Impact energy	1.2 Joules
Net Weight	2.5kg
No Load Speed	0 - 680 rpm



Δεν συμπεριλαμβάνει μπαταρία και φορτιστή  
Does not include battery and charger

**BL MOTOR LITHIUM-ION LXT**

## DHR182ZJ



€443.00

18V SDS+ Κρουστικό περιστροφικό τράπανο 18mm

SDS-Plus rotary hammer 18mm 18v

Optimum Drilling	3.2 - 10 mm
Capacity Concrete	18 mm
Capacity Steel	13 mm
Capacity Wood	24 mm
Impact rate	0-5000ipm
Impact energy	1.7 Joules
Net Weight	3.2 kg
No Load Speed	0 - 1350 rpm



**NEW**

Δεν συμπεριλαμβάνει μπαταρία και φορτιστή  
Does not include battery and charger

**BL MOTOR LITHIUM-ION LXT AVT AWS**

HR166DZ



## DHR243Z €468.00

18V SDS-Plus Κρουστικό περιστροφικό τράπανο 24mm

SDS-Plus rotary hammer 24mm 18v

Optimum Drilling	4 - 16 mm
Capacity Concrete	24 mm
Capacity Steel	13 mm
Capacity Wood	27 mm
Blows per minute	0-4700bpm
Impact energy	2.0 Joules
Net Weight	3.5kg
No Load Speed	0 - 950 rpm

Δεν συμπεριλαμβάνει μπαταρία και φορτιστή  
Does not include battery and charger

**BL MOTOR LITHIUM-ION**

Easy-to-grip handle ergonomically designed to:

- give maximum power thrust.
- provide a sure and comfortable grip in any operation; overhead application, drilling with palm-up or palm-down grip.



### Dust extraction system for DHR243

Find in accessories section



DHR243Z



## DHR263ZJ €412.00

36 (18V x2) V SDS-Plus Κρουστικό τράπανο

**NEW**

36 (18V x2) V SDS-Plus Rotary hammer

Optimum Drilling	4 - 18 mm
Capacity Concrete	26 mm
Capacity Steel	13 mm
Capacity Wood	32 mm
Blows per minute	0 - 4,800bpm
Impact energy	2.5 Joules
Net Weight	4.7kg
No Load Speed	0 - 1,250rpm

Δεν συμπεριλαμβάνει μπαταρία και φορτιστή  
Does not include battery and charger

**LITHIUM-ION 18v + 18v → 36V LXI**



## DHR264ZJ €442.00

36 (18V x2) V SDS-Plus Κρουστικό τράπανο

36 (18V x2) V SDS-Plus Rotary hammer chuck

Optimum Drilling	4 - 16 mm
Capacity Concrete	26 mm
Capacity Steel	13 mm
Capacity Wood	32 mm
Blows per minute	0 - 4,800bpm
Impact energy	2.5 Joules
Net Weight	4.7kg
No Load Speed	0 - 1,200rpm

Δεν συμπεριλαμβάνει μπαταρία και φορτιστή  
Does not include battery and charger

**LITHIUM-ION 18v + 18v → 36V LXI**



## DHR400G2UN €1652.00

36 (18V x2) V SDS-Max Κρουστικό τράπανο 40mm

36 (18V x2) V SDS-Max Rotary Hammer 40mm

Optimum Drilling	18 - 25 mm
Capacity Concrete	40 mm
Capacity Concrete (TCT core)	105 mm
Blows per minute	1450 - 2900 bpm
Impact energy	8.0 Joules
Net Weight	7.6kg
No Load Speed	250 - 500 rpm

Συμπεριλαμβάνει θήκη μεταφοράς  
Includes carrying case

**LITHIUM-ION 18v + 18v → 36V LXI BL MOTOR AVT AWS**

  
Adapted for SDS-MAX bits

Includes:

- 2x 6.0Ah batteries (BL1860B),
- Dual port rapid charger (DC18RD)
- AWS receiver (198901-5)



**18v + 18v → 36V**

## HP33DWAE €221.00

12Vmax Κρουστικό τράπανο

12Vmax Combi Drill CXT

Capacity Steel	10 mm
Capacity Wood	21 mm
Capacity Masonry	8 mm
Chuck Capacity	0.8 - 10 mm
No Load Speed	0 - 1,700/450 rpm
Max Torque S/H	14 / 30 Nm
Net Weight	1.2kg

Συμπεριλαμβάνει δύο μπαταρίες και φορτιστή  
Includes two batteries and charger

**LITHIUM-ION 12Vmax CXT**



FORWARD  
MAX  
30  
N.m  
REVERSE

## DHP458Z €176.00

18V Κρουστικό τράπανο

18V Percussion Drill

Capacity Steel	13 mm
Capacity Wood	65 mm
Capacity Masonry	16 mm
Impact rate	0-30000/6000 bpm
Max Torque S/H	58 / 91 Nm
Net Weight	2.2kg
No Load Speed	0-2000/400 rpm

Δεν συμπεριλαμβάνει μπαταρία και φορτιστή  
Does not include battery and charger

**LITHIUM-ION LXT METAL GEAR BOX**



FORWARD  
MAX  
91  
N.m  
REVERSE

## DHP482Z €130.50

18V Κρουστικό τράπανο

18V Hammer Driver Drill

Capacity Steel	13 mm
Capacity Wood	38 mm
Capacity Masonry	13 mm
Chuck Capacity	1.5 - 13 mm
No Load Speed	0-1900/600 rpm
Blows per Minute	0-28,500/9,000 ipm
Net Weight	1.5 - 1.8kg

Δεν συμπεριλαμβάνει μπαταρία και φορτιστή  
Does not include battery and charger

**LITHIUM-ION LXT METAL GEAR BOX**



FORWARD  
MAX  
62  
N.m  
REVERSE

## DHP484Z €197.00

18V Κρουστικό τράπανο

18V Brushless Combi drill

Capacity Steel	13 mm
Capacity Wood	38 mm
Capacity Masonry	13 mm
Chuck Capacity	1.5 - 13 mm
No Load Speed	0-2000/500 rpm
Blows per Minute	0 - 30,000/7,500 ipm
Net Weight	1.6 - 1.9kg

Δεν συμπεριλαμβάνει μπαταρία και φορτιστή  
Does not include battery and charger

**BL MOTOR LITHIUM-ION LXT METAL GEAR BOX**



FORWARD  
MAX  
54  
N.m  
REVERSE

## DHP490Z €140.00

18V Κρουστικό τράπανο

18V Brushless Combi drill

Capacity Steel	13 mm
Capacity Wood	38 mm
Capacity Masonry	13 mm
Chuck Capacity	1.5 - 13 mm
No Load Speed	0-500/1900 rpm
Blows per Minute	0-7500/28500 ipm
Net Weight	1,0 - 1,7 kg

Δεν συμπεριλαμβάνει μπαταρία και φορτιστή  
Does not include battery and charger

**BL MOTOR LITHIUM-ION LXT**



NEW

FORWARD  
MAX  
65  
N.m  
REVERSE

## DHP485Z €204.00

18V Κρουστικό τράπανο

18V Brushless Combi drill

Capacity Steel	13 mm
Capacity Wood	38 mm
Capacity Masonry	13 mm
Chuck Capacity	1.5 - 13 mm
No Load Speed	0-1900/500 rpm
Blows per Minute	0 - 28,500 / 7,500 ipm
Net Weight	1.5 - 1.8kg

Δεν συμπεριλαμβάνει μπαταρία και φορτιστή  
Does not include battery and charger

**BL MOTOR LITHIUM-ION LXT METAL GEAR BOX**



FORWARD  
MAX  
50  
N.m  
REVERSE

## DHP492Z €370.00

18V Κρουστικό τράπανο

18V Brushless Combi drill

Capacity Steel	13 mm
Capacity Wood	76 mm
Capacity Masonry	16 mm
Chuck Capacity	1.5 - 13 mm
No Load Speed	0- 2100/550 rpm
Blows per Minute	0 - 31,500 / 8,250 ipm
Net Weight	1.7kg

Δεν συμπεριλαμβάνει μπαταρία και φορτιστή  
Does not include battery and charger

**BL MOTOR LITHIUM-ION LXT METAL GEAR BOX**



FORWARD  
MAX  
130  
N.m  
REVERSE

DHP486Z



## DF033DWAE €256.00

12V Κατσαβίδι

12V Drill Driver

Capacity Steel	10 mm
Capacity Wood	21 mm
Max Torque S/H	14/30 Nm
Torque setting	20
Net Weight	0.9kg
No Load Speed	0-1700rpm/450 rpm

Συμπεριλαμβάνει δύο μπαταρίες και φορτιστή  
Includes two batteries and charger

**LITHIUM-ION CXT**



## DF333DWAE €233.00

12Vmax Κατσαβίδι

12Vmax Cordless driver drill

Capacity Steel	10 mm
Capacity Wood	21 mm
Max Torque S/H	14/30 Nm
Chuck Capacity	0.8-10 mm
Net Weight	1.1kg
No Load Speed	0 - 1,700/450 rpm

Συμπεριλαμβάνει δύο μπαταρίες και φορτιστή  
Includes two batteries and charger

**LITHIUM-ION 12Vmax CXT**



## DA333DWAE €296.00

12V Γωνιακό κατσαβίδι

12V Angle drill

Capacity Steel	10 mm
Capacity Wood	12 mm
Chuck Capacity	0.8-10 mm
Net Weight	1.2kg
No Load Speed	0 - 1,100 rpm

Συμπεριλαμβάνει δύο μπαταρίες και φορτιστή  
Includes two batteries and charger

**LITHIUM-ION CXT**



## DDA351Z €251.00

18V Γωνιακό κατσαβίδι

18V Angle drill

Capacity Steel	10 mm
Capacity Wood	25 mm
Max Torque	13.7 Nm
Net Weight	1.6kg
No Load Speed	0 - 1,800 rpm

Δεν συμπεριλαμβάνει μπαταρία και φορτιστή  
Does not include battery and charger

**LITHIUM-ION LXT**



## TD110DWAE €204.00

12V Παλμικό κατσαβίδι

12V Impact Driver

No Load Speed	0 - 2,600 rpm
Blows per Minute	0 - 3,500 ipm
Driving Shank	1/4" Hex (6.35mm)
Max Torque	110 Nm
Net Weight	1.0kg

Συμπεριλαμβάνει δύο μπαταρίες και φορτιστή  
Includes two batteries and charger

**LITHIUM-ION CXT**



## TD110DZ (tool only) €80.00

## TD126DWE €209.00

14.4V Παλμικό κατσαβίδι

14.4V Impact Driver

No Load Speed	0 - 2,400 rpm
Blows per Minute	0 - 3,000 ipm
Max Torque	135 Nm
Net Weight	1.4kg

Συμπεριλαμβάνει δύο μπαταρίες και φορτιστή  
Includes two batteries and charger

**LITHIUM-ION LXT G-SERIES**



TD111DSAJ

## TD111DSAJ €344.00

12V Max Παλμικό κατσαβίδι

12V Max Brushless Impact Driver

No Load Speed	0 - 3,000 rpm
Blows per Minute	0 - 3,900 ipm
Driving Shank	1/4" Hex (6.35mm)
Max Torque	135Nm
Net Weight	1.1kg

Συμπεριλαμβάνει δύο μπαταρίες και φορτιστή  
Includes two batteries and charger

**BL MOTOR LITHIUM-ION CXT**



## TD111DZ (tool only) €173.50

## DTD152Z €119.00

18V Παλμικό κατσαβίδι 6.35mm (1/4")

18V Impact Driver

No Load Speed	0 - 2,900 rpm
Blows per Minute	0 - 3,500 ipm
Driving Shank	1/4" Hex (6.35mm)
Max Torque	165 Nm
Net Weight	1.3 - 1.6 kg

Δεν συμπεριλαμβάνει μπαταρία και φορτιστή  
Does not include battery and charger

**LITHIUM-ION LXT**



FORWARD  
MAX  
165  
N.m  
REVERSE

## DTD153Z €199.00

18V Παλμικό κατσαβίδι 6.35mm (1/4")

18V Brushless Impact Driver

No Load Speed	0 - 3,400 rpm
Blows per Minute	0 - 3,600 ipm
Driving Shank	1/4" Hex (6.35mm)
Max Torque	170 Nm
Net Weight	1.5 kg

Δεν συμπεριλαμβάνει μπαταρία και φορτιστή  
Does not include battery and charger

**BL MOTOR LITHIUM-ION LXT**



FORWARD  
MAX  
170  
N.m  
REVERSE

## DTD156Z €109.00

18V Παλμικό κατσαβίδι 6.35mm (1/4")

18V Impact Driver

No Load Speed	0 - 2,500 rpm
Blows per Minute	0 - 3,000 ipm
Driving Shank	1/4" Hex (6.35mm)
Max Torque	155 Nm
Net Weight	1.3 kg

Δεν συμπεριλαμβάνει μπαταρία και φορτιστή  
Does not include battery and charger

**LITHIUM-ION LXT**



FORWARD  
MAX  
155  
N.m  
REVERSE

## DTD157Z €131.00

18V Παλμικό κατσαβίδι 6.35mm (1/4")

18V Brushless Impact Driver

No Load Speed	0 - 3,000/1,300 rpm
Blows per Minute	0 - 4,100/2,000 ipm
Driving Shank	1/4" Hex (6.35mm)
Max Torque	140 Nm
Net Weight	1.2 - 1.5 kg

Δεν συμπεριλαμβάνει μπαταρία και φορτιστή  
Does not include battery and charger

**BL MOTOR LITHIUM-ION LXT**



FORWARD  
MAX  
140  
N.m  
REVERSE



DTD173

## DTD173Z €173.00

18V Παλμικό κατσαβίδι 6.35mm (1/4")

18V Brushless Impact Driver

Coarse thread (length)	22 - 125 mm
Blows per Minute	0 - 3800 ipm
Driving Shank	1/4" Hex (6.35mm)
Max Torque	180 Nm
Net Weight	1.2 - 1.5 kg

Compact tool body of 114mm  
Δεν συμπεριλαμβάνει μπαταρία και φορτιστή  
Does not include battery and charger

**BL MOTOR LITHIUM-ION LXT**



FORWARD  
MAX  
180  
N.m  
REVERSE

## ΕΠΑΝΑΦΟΡΤΙΖΟΜΕΝΗ

CORDLESS TECHNOLOGY

ΤΕΧΝΟΛΟΓΙΑ



## WR100DZ €199.50

12V Κατσαβίδι Καστανίας

12V Ratchet wrench

No Load Speed	0 - 800 rpm
Flats Width	13 mm
Driving Shank	3/8" or 1/4" Square
Max Torque	47.5 Nm
Net Weight	1.0 kg

Δεν συμπεριλαμβάνει μπαταρία και φορτιστή  
Does not include battery and charger

**LITHIUM-ION 12V<sub>max</sub> CXT**



FORWARD  
MAX  
47.5  
N.m  
REVERSE



WR100DZ

## TW140DZ €85.00

12V Παλμικός βιδολόγος 3/8"

12V Impact wrench 3/8"

No Load Speed	0 - 2,600 rpm
Nut Busting Torque	270Nm
Driving Shank	3/8" Square
Max Torque	140 Nm
Net Weight	1.0 kg

Δεν συμπεριλαμβάνει μπαταρία και φορτιστή  
Does not include battery and charger

**LITHIUM-ION 12V<sub>max</sub> CXT**



FORWARD  
MAX  
140  
N.m  
REVERSE

## TW141DZ €108.00

12V Παλμικός βιδολόγος 1/2"

12V Impact wrench 1/2"

No Load Speed	0 - 2,600 rpm
Nut Busting Torque	270Nm
Driving Shank	1/2" Square
Max Torque	145 Nm
Net Weight	1.1 kg

Δεν συμπεριλαμβάνει μπαταρία και φορτιστή  
Does not include battery and charger

**LITHIUM-ION 12V<sub>max</sub> CXT**



FORWARD  
MAX  
145  
N.m  
REVERSE

## DTW181Z €173.00

18V Παλμικός βιδολόγος 1/2"

18V Brushless Impact wrench 1/2"

No Load Speed	0 - 2,400/1,300 rpm
Nut Busting Torque	330Nm
Driving Shank	1/2" Square
Max Torque	210 Nm
Net Weight	1.0 kg

Δεν συμπεριλαμβάνει μπαταρία και φορτιστή  
Does not include battery and charger

**BL MOTOR LITHIUM-ION LXT**



FORWARD  
MAX  
210  
N.m  
REVERSE

## DTW190Z €106.00

18V Παλμικός βιδολόγος 1/2"

18V Impact wrench 1/2"

No Load Speed	0 - 2,300 rpm
Blows per Minute	0-3,000 ipm
Driving Shank	1/2" Square
Max Torque	190 Nm
Net Weight	1.4 kg

Δεν συμπεριλαμβάνει μπαταρία και φορτιστή  
Does not include battery and charger

**BL MOTOR LITHIUM-ION LXT**



FORWARD  
MAX  
190  
N.m  
REVERSE

## DTW300Z €260.00

18V Παλμικός βιδολόγος 1/2"

18V Brushless Impact wrench 1/2"

No Load Speed	0 - 3,200 / 2,600 / 1,800 / 1,000 rpm
Blows per Minute	0 - 4,000 ipm
Nut Busting Torque	580Nm
Driving Shank	1/2" Square
Max Torque	330 Nm
Net Weight	1.5 - 1.8 kg

Δεν συμπεριλαμβάνει μπαταρία και φορτιστή  
Does not include battery and charger

**BL MOTOR LITHIUM-ION LXT**



FORWARD  
MAX  
330  
N.m  
REVERSE

## DTW Impact Wrench Bit adapter

Find in **accessories** section



**NEW**

## DTW450Z €335.00

18V Παλμικός βιδολόγος 1/2"

18V Brushless Impact wrench 1/2"

No Load Speed	0 - 1,600 rpm
Blows per Minute	2200ipm
Nut Busting Torque	580Nm
Driving Shank	1/2" Square
Max Torque	440 Nm
Net Weight	3.1 - 3.4 kg

Δεν συμπεριλαμβάνει μπαταρία και φορτιστή  
Does not include battery and charger

**LITHIUM-ION**



FORWARD  
MAX  
440  
N.m  
REVERSE

## DTW700Z €438.00

18V Παλμικός βιδολόγος 1/2"

18V Brushless Impact wrench 1/2"

No Load Speed	0 - 500 / 1200 / 1900 / 2200 rpm
Blows per Minute	0 - 1000 / 1700 / 2400 / 2700 ipm
Nut Busting Torque	1000Nm
Driving Shank	1/2" Square
Max Torque	150 / 200 / 320 / 700 Nm
Net Weight	2,0 kg

Δεν συμπεριλαμβάνει μπαταρία και φορτιστή  
Does not include battery and charger

**BL MOTOR LITHIUM-ION LXT**



FORWARD  
MAX  
700  
N.m  
REVERSE

## DTW1001Z €510.00

18V Παλμικός βιδολόγος 3/4"

18V Brushless Impact wrench 3/4"

No Load Speed	0 - 1,800 / 1,000 / 900 rpm
Blows per Minute	0 - 2,200 / 2,000 / 1,800 ipm
Nut Busting Torque	1700Nm
Driving Shank	3/4" Square
Max Torque	1050 Nm
Net Weight	3.4 - 3.7 kg

Δεν συμπεριλαμβάνει μπαταρία και φορτιστή  
Does not include battery and charger

**BL MOTOR LITHIUM-ION LXT**



FORWARD  
MAX  
1050  
N.m  
REVERSE

## DTW1002Z €488.00

18V Παλμικός βιδολόγος 1/2"

18V Brushless Impact wrench 1/2"

No Load Speed	0 - 1,800 / 1,000 / 900 rpm
Blows per Minute	0 - 2,200 / 2,000 / 1,800 ipm
Nut Busting Torque	1600Nm
Driving Shank	1/2" Square
Max Torque	1000 Nm
Net Weight	3.3 - 3.6 kg

Δεν συμπεριλαμβάνει μπαταρία και φορτιστή  
Does not include battery and charger

**BL MOTOR LITHIUM-ION LXT**



FORWARD  
MAX  
1000  
N.m  
REVERSE

## DTW1004Z €496.00

18V Παλμικός βιδολόγος 1/2"

18V Brushless Impact wrench 1/2"

No Load Speed	0 - 900 / 1,000 / 2000 rpm
Blows per Minute	0 - 1800 / 2,000 / 2,400 ipm
Nut Busting Torque	1300Nm
Driving Shank	1/2" Square
Max Torque	170 / 250 / 1050 Nm
Net Weight	2.7 kg

Δεν συμπεριλαμβάνει μπαταρία και φορτιστή  
Does not include battery and charger

**BL MOTOR LITHIUM-ION LXT**



NEW

FORWARD  
MAX  
1050  
N.m  
REVERSE

## DAS180Z €258.00

18V Φυσστήρας

18V Dust Blower

Max. Air Velocity	0 - 200 m/s
Blowing force	0 - 1,1 / 1,7 / 2,3 / 2,8 N
Air volume	0 - 1,1 m <sup>3</sup> /min
Max. sealed suction	103 mbar
Max Pressure	0,297 bar
Net Weight	1.7 kg

Δεν συμπεριλαμβάνει μπαταρία και φορτιστή  
Does not include battery and charger

**LITHIUM-ION LXT**



\*4 Stage air volume, selectable according to your application

## DHG181ZJ €287.50

18V Πιστόλι Θερμού Αέρα

18V Heat Gun

Nozzle joint portion	34.5 mm
Maximum Flow Rate	120 - 200 L/min
Temperature Range	150 - 550 °
Maximum Output	10 w
Net Weight	1.2 kg

Δεν συμπεριλαμβάνει μπαταρία και φορτιστή  
Does not include battery and charger

**LITHIUM-ION LXT**



Blowing

Deflating

Inflating

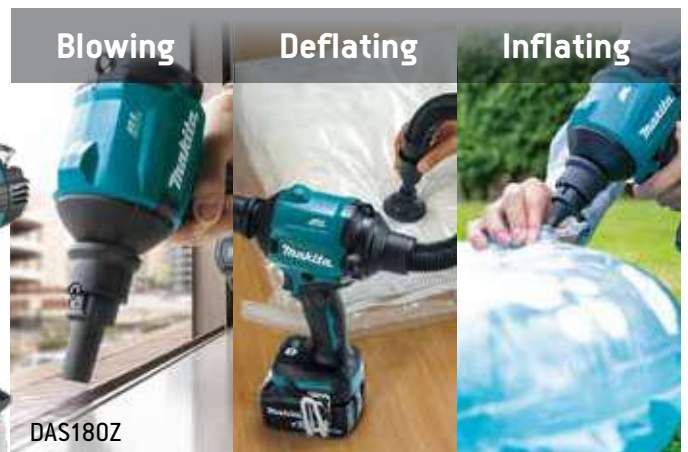

DAS180Z

## DFS451Z €204.00

18V Κατσαβίδι γυψοσανίδας 1/4"

18V Drywall screwdriver 1/4"

Driving Shank	1/4" Hex
Max. Drywall Screw	4mm
No Load Speed	0-4000rpm
Net Weight	1.5 kg

Δεν συμπεριλαμβάνει μπαταρία και φορτιστή  
Does not include battery and charger

**LITHIUM-ION** **LXT** **4000 rpm**



## DFS452Z €319.00

18V Κατσαβίδι γυψοσανίδας 1/4"

18V Brushless Drywall screwdriver 1/4"

Driving Shank	1/4" Hex
Max. Drywall Screw	5mm
Self Drilling Screw	6mm
No Load Speed	0-4000rpm
Net Weight	1.5 kg

Δεν συμπεριλαμβάνει μπαταρία και φορτιστή  
Does not include battery and charger

**BL MOTOR** **LITHIUM-ION** **LXT** **4000 rpm**



## DFS-FS Drywall Autofeeder

Find in accessories section 

**NEW**



## DC0180Z €192.00

18V Κόπτης γυψοσανίδας 1/8"

18V Drywall cutter 1/8"

Collet capacity	1/8
Stroke length	11.5 - 31.0mm
Max Output	590W
No Load Speed	30000rpm
Run Time	225min/BL1850
Net Weight	1.6 kg

Δεν συμπεριλαμβάνει μπαταρία και φορτιστή  
Does not include battery and charger

**LITHIUM-ION** **LXT**



## DSD180Z €317.00

18V Κόπτης γυψοσανίδας

18V Brushless Drywall cutter

Strokes per minute	0 - 6,000spm
Stroke length	6mm
Capacity in drywall	30 mm
Capacity in Wood	15 mm
Blade for Drywall	55 x 18 x 0.55 mm
Blade for wood	53 x 18 x 0.55 mm
Run Time	360min/BL1850
Net Weight	1.9 kg

Δεν συμπεριλαμβάνει μπαταρία και φορτιστή  
Does not include battery and charger

**BL MOTOR** **LITHIUM-ION** **LXT**



## DC0181Z €260.00

18V Κόπτης γυψοσανίδας 1/8"

18V Brushless Drywall cutter 1/8"

Collet capacity	1/8 or 1/4"
Stroke length	9.2 - 31 mm
Max Output	600W
No Load Speed	32000rpm
Net Weight	1.6 kg

Δεν συμπεριλαμβάνει μπαταρία και φορτιστή  
Does not include battery and charger

**BL MOTOR** **LITHIUM-ION** **LXT**



## Drywall blade for DSD180Z

Find in accessories section



## Wood blade for DSD180Z

Find in accessories section



DC0181Z

## DPT353Z €482.00

### 18V Καρφωτικό βελόνων

#### 18V Pin Nailer

Nail Gauge	23 Ga
Nail Magazine Capacity	100
Nail range	15, 18, 25, 30, 35 mm
Run Time	5300 pcs/BL1850 6400 pcs/BL1860
Net Weight	2.0 - 2.3 kg

Δεν συμπεριλαμβάνει μπαταρία και φορτιστή  
Does not include battery and charger

**LITHIUM-ION LXT**



## DST221Z €407.00

### 18V Καρφωτικό "Π"

#### 18V Stapler

Shots per battery charge (3.0ah)	6,000
Staple Length/Gauge	0.6 x 1.2 mm
Staple Magazine Capacity	98
Staple range	10, 13, 16, 19, 22mm
Staple width	10 mm
Run Time	3000 Π/BL1850
Net Weight	2.1 - 2.4 kg

Δεν συμπεριλαμβάνει μπαταρία και φορτιστή  
Does not include battery and charger

**LITHIUM-ION LXT**



## GN420CSE €1229.00

### 7.2V Πιστόλα γκαζιού

#### 7.2V Concrete Gas Nailer

Nail Gauge	2.6-3.0 Ga
Nail Length	15-40 mm
Shots per battery charge	4,000 shots
Work amount per fuel cell	1,200 shots
Nail Mag. Capacity	20
Net Weight	3.6 kg

Δεν συμπεριλαμβάνει μπαταρία και φορτιστή  
Does not include battery and charger

**LITHIUM-ION**



## GN900SE €855.00

### 7.2V Πιστόλα γκαζιού

#### 7.2V First Fix Gas Nailer

Magazine Angle	34°
Nail Length	50 - 90 mm
Nail type	Clipped head
Shots per battery charge	4,000 shots
Shots per gas cell	1,200 shots
Gas	80ml cartridge/ButanePropane
Nail Mag. Capacity	44
Net Weight	3.3 - 3.4 kg

Δεν συμπεριλαμβάνει μπαταρία και φορτιστή  
Does not include battery and charger

**LITHIUM-ION**



## DFN350ZJ **NEW** €702.00

### 18V Καρφωτικό Φινιρίσματος

#### 18V Finishing Nailer

Nail Gauge	18 Ga
Nail Length	15-35 mm
Shots per battery charge	4000 shots
Nail type	Finish
Nail Magazine Capacity	110
Net Weight	2.1 - 2.4 kg

Δεν συμπεριλαμβάνει μπαταρία και φορτιστή  
Does not include battery and charger

**LITHIUM-ION LXT**



## DBN500ZJ **NEW** €797.00

### 18V Καρφωτικό Φινιρίσματος

#### 18V Finishing Nailer

Nail Gauge	18 Ga
Nail Length	15-50 mm
Shots per battery charge	1000 shots
Nail type	Finish
Nail Magazine Capacity	110
Net Weight	2.9 kg

Δεν συμπεριλαμβάνει μπαταρία και φορτιστή  
Does not include battery and charger

**LITHIUM-ION LXT**



### Nailer Finishing Nails

Find in accessories section 



Συμβατές μόνο για το DBN600ZJ  
Compatible only for DBN600ZJ



## DBN601ZJ €600.00

### 18V Καρφωτικό Φινιρίσματος

#### 18V Finishing Nailer 16G

Nail Gauge	16 Ga
Nail Length	25-64 mm
Shots per battery charge	800 shots
Nail type	Finish
Nail Magazine Capacity	110
Net Weight	3.4 - 3.8 kg

Δεν συμπεριλαμβάνει μπαταρία και φορτιστή  
Does not include battery and charger

**LITHIUM-ION LXT**



## DFR550Z

€343.00

18V Κατσαβίδι γυψοσανίδας

18V Auto feed screwdriver

Screw Size Range	25 to 55 mm
Max. Drywall Screw	4mm x 55mm
No Load Speed	0-4000rpm
Net Weight	1.5 kg

Δεν συμπεριλαμβάνει μπαταρία και φορτιστή  
Does not include battery and charger

**LITHIUM-ION** **LXT** **4000 rpm**



## DFR750Z

€385.50

18V Κατσαβίδι γυψοσανίδας

18V Auto feed screwdriver

Screw Size Range	45 - 75 mm
Max. Drywall Screw	4mm x 55mm
No Load Speed	0-4000rpm
Net Weight	2,1 - 3,2 kg

Δεν συμπεριλαμβάνει μπαταρία και φορτιστή  
Does not include battery and charger

**LITHIUM-ION** **LXT** **4000 rpm**



DFR550Z



Extension Handle 890 – 990 mm

Find in **accessories** section



DRV150Z



Compatible with various sizes  
of blind rivets

## DRV150Z

€1125.00

18V Πριτσιναδόρος

18V Brushless Rivet Gun

Stroke	25 mm
Pulling Force	10 kN
Rivet Diameter	2.4 - 4.8 mm
Run Time	1166pcs/BL1850
Net Weight	1.9 - 2.2 kg

Δεν συμπεριλαμβάνει μπαταρία και φορτιστή  
Does not include battery and charger

**BL MOTOR** **LITHIUM-ION** **LXT**



## DRV250Z

€1180.00

18V Πριτσιναδόρος

18V Brushless Rivet Gun

Stroke	30 mm
Pulling Force	20 kN
Rivet Diameter	4.8 - 6.4 mm
Net Weight	2.1 - 2.4 kg

Δεν συμπεριλαμβάνει μπαταρία και φορτιστή  
Does not include battery and charger

**BL MOTOR** **LITHIUM-ION** **LXT**



**DKP180Z****€226.00**

18V Πλάνη 82mm

18V Planer 82mm

No Load Speed	14000 rpm
Planing Depth	2.0 mm
Planing Width	82 mm
Max Rebate Depth	9.0 mm
Run Time	91min/BL1850 1mm ΞΥΛΟ
Net Weight	3.2 - 3.5 kg

Δεν συμπεριλαμβάνει μπαταρία και φορτιστή  
Does not include battery and charger**LITHIUM-ION**

2.0 mm

**DKP181Z****€410.00**

18V Πλάνη 82mm

18V Brushless Planer 82mm

No Load Speed	12,000 rpm
Planing Depth	3.0 mm
Planing Width	82 mm
Max Rebate Depth	25 mm
Net Weight	3.3 - 3.6 kg

Δεν συμπεριλαμβάνει μπαταρία και φορτιστή  
Does not include battery and charger**BL MOTOR LITHIUM-ION LXT AWS ADT**

3.0 mm

**DB0180Z****€160.00**

18V Κυκλοπαλμικό τριβείο 125mm (5")

18V Random orbit sander 125mm (5")

Speed Control	3 stage push button
Orbits per Minute	7000/9500/11000 rpm
Orbit Diameter	2.8 mm
Paper Fastening	Hook & Loop
Pad Size	123 mm
Net Weight	1.4 - 1.7 kg

Δεν συμπεριλαμβάνει μπαταρία και φορτιστή  
Does not include battery and charger**LITHIUM-ION****DKP181ZU****€490.00**

18V Πλάνη 82mm σε θήκη ΜΑΚΡΑC

18V Brushless Planer 82mm in MAKPAC Case

**DRT50ZJ****€291.50**

Ρούτερ παλάμης 3/8" &amp; 1/4"

18V Brushless Router/Trimmer

Collet Capacity	3/8" and 1/4"
No Load Speed	10,000 - 30,000 rpm
Run Time	83min/BL1850
Net Weight	1.8 - 2.1 kg

Δεν συμπεριλαμβάνει μπαταρία και φορτιστή  
Does not include battery and charger**BL MOTOR LITHIUM-ION LXT**

- Includes:**
- Trimmer Base
  - Straight Guide
  - Dust Nozzle for Trimmer Base
  - Hex Wrench x2
  - Collet Cone
  - Template Guide for Trimmer
  - Makpac Type 4 case

**DBS180Z****NEW****€398.00**

18V Ταϊνιακό τριβείο

18V Belt Sander

Belt Speed	600 - 1700 m/min
Belt Size	9 x 533 mm
Angle range vertical	160°
Vacuum cleaner	Ø in / out 17/22 mm
Net Weight	1.4

Δεν συμπεριλαμβάνει μπαταρία και φορτιστή  
Does not include battery and charger**BL MOTOR LITHIUM-ION LXT****DRT50ZJX3****€520.00**

Ρούτερ παλάμης 3/8" &amp; 1/4"

Δεν συμπεριλαμβάνει μπαταρία και φορτιστή  
Does not include battery and charger

- Includes:**
- Trimmer Base
  - Straight Guide
  - Dust Nozzle for Trimmer Base
  - Hex Wrench x2
  - Collet Cone
  - Template Guide for Trimmer
  - Trimmer Guide
  - Plunge Base
  - Tilt Base
  - Offset Base
  - Dust Nozzle for Plunge Base
  - Grip 36
  - Template Guide for Plunge Base
  - Grip Attachment
  - Guide Holder
  - Makpac Type 4 case

**Router Bases**Find in **accessories** section

## DCS553ZJ €358.00

18V Πριόνι μετάλλου 150mm

18V Brushless metal cutting saw

Blade Diameter	150 mm
Max Cut @ 0°	57.5 mm
Bore Diameter	20 mm
No Load Speed	4,200 rpm
Net Weight	2.8 - 3.1 kg

Δεν συμπεριλαμβάνει μπαταρία και φορτιστή  
Does not include battery and charger

**BL MOTOR LITHIUM-ION LXT ADT**



## DHS660Z €407.00

18V Δισκοπρίνο 165mm

18V Brushless Circular saw 165mm

Blade Diameter	165 mm
Max Cut @ 0°	57 mm
Bore Diameter	20 mm
No Load Speed	5,000 rpm
Net Weight	2.9 - 3.2 kg

Δεν συμπεριλαμβάνει μπαταρία και φορτιστή  
Does not include battery and charger

**BL MOTOR LITHIUM-ION LXT ADT**



## B-69325 €68.00

TCT Efficut Saw Blade 150x20x33T (Metal)



## DLS600Z €1028.00

18V Δισκοπρίνο πάγκου 165mm

18V Brushless Miter saw 165mm (6-1/2")

Bore Diameter	165 mm
Bore Diameter	20 mm
No Load Speed	5,000 rpm
Max bevel range	46 - 46°
Max mitre range	52 - 52°
Max Cutting Capacity	46 x 92 mm
Net Weight	6.3 - 6.6 kg

Δεν συμπεριλαμβάνει μπαταρία και φορτιστή  
Does not include battery and charger

**BL MOTOR LITHIUM-ION LXT ADT DXT**



## DHS660ZJ €426.00

18V Δισκοπρίνο 165mm σε θήκη ΜΑΚΡΑΚ

18V Brushless Circular saw 165mm in MAKPAC Case



## DSS610Z €227.00

18V Δισκοπρίνο 165mm

18V Circular saw 165mm

Blade Diameter	165 mm
Depth of Cut @ 90° / 45° / 50°	57 / 40 / 36 mm
Bore Diameter	20 mm
No Load Speed	3,700 rpm
Net Weight	3.0 - 3.4 kg

Δεν συμπεριλαμβάνει μπαταρία και φορτιστή  
Does not include battery and charger

**LITHIUM-ION**



## DHS710ZJ €393.00

36 (18V x2) V Δισκοπρίνο 185mm

36 (18V x2) Circular saw 185mm

Blade Diameter	190 mm
Max Cut @ 0°	66 mm
Bore Diameter	20/30 mm
No Load Speed	4,600 rpm
Net Weight	3.9 - 4.6 kg

Δεν συμπεριλαμβάνει μπαταρία και φορτιστή  
Does not include battery and charger

**LITHIUM-ION 18V + 18V → 36V LXT**



## DRS780Z NEW €482.50

36V (18x2)V Δισκοπρίνο 185mm

36V (18x2) Circular Saw 185mm

Blade Diameter	185 mm
Depth of Cut @ 90° / 45° / 53°	65 / 45 / 38 mm
Bore Diameter	20/30 mm
No Load Speed	5,100 rpm
Net Weight	5.0 - 5.6 kg

Δεν συμπεριλαμβάνει μπαταρία και φορτιστή  
Does not include battery and charger

**LITHIUM-ION 18V + 18V → 36V LXT BL MOTOR**



## DLW140Z €487.00

36 (18V x2) V Κόφτης μετάλλων 355mm

36 (18V x2) Brushless V cut-off saw 355mm

Bore Diameter	25.4 mm
Max Wheel Thickness	3.0 mm
Max Wheel Diameter	355 mm
Maximum Output	1,300 w
No Load Speed	3,800 rpm
Net Weight	17.2 - 17.8 kg

Δεν συμπεριλαμβάνει μπαταρία και φορτιστή  
Does not include battery and charger

**BL MOTOR LITHIUM-ION 18V + 18V → 36V LXT**



## DHS900Z €710.00

36 (18V x2) V Δισκοπρίνο 235mm

36 (18V x2) Brushless Circular saw 235mm

Blade Diameter	235 mm
Max Cut @ 0°	85 mm
Bore Diameter	30 mm
No Load Speed	4,500 rpm
Net Weight	5.3 - 6.0 kg

Δεν συμπεριλαμβάνει μπαταρία και φορτιστή  
Does not include battery and charger

**LITHIUM-ION 18V + 18V → 36V LXT BL MOTOR**



**AWS** Auto-Start Wireless System (AWS)  
Connects to compatible dust extractors with Bluetooth.

**DSP601ZJU**  **€674.00**

36 (18V x2) V Κόφτης 165mm

36 (18V x2) Brushless Plunge cut saw 165mm

Blade Diameter	165 mm
Max Cut @ 0°	56 mm
Bore Diameter	20 mm
No Load Speed	2,500 - 6,300 rpm
Net Weight	4.4 - 5.1 kg

Δεν συμπεριλαμβάνει μπαταρία και φορτιστή  
Does not include battery and charger



**LITHIUM-ION**  **36V LXT MOTOR AWS**

**ADT**

**Automatic Torque Drive Technology:** Automatically changes the cutting speed according to load condition for optimum operation

**Guide Rails**

Find in accessories section 

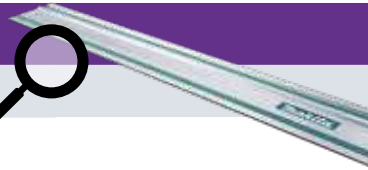

**DPB180Z**  **€581.00**

18V Φορητή ηριονοκορδέλα

18V Portable band saw

Round Pipe diameter	120 mm
Square Pipe	120 x 120 mm
Blade Speed	1.4 - 2.7 m/sec
Net Weight	6.8 - 7.1 kg

Δεν συμπεριλαμβάνει μπαταρία και φορτιστή  
Does not include battery and charger

**LITHIUM-ION LXT**



**DLS211ZU**  **€1634.50**

36 (18V x2) V Δισκοπήρινο πάγκου μπαταρίας 305mm

36 (18V x2) Brushless Slide Compound Saw 305m

Max Cutting Capacity	92 x 382 mm
Blade diameter	305mm (12")
Max mitre range	60 - 60°
Bore Diameter	30 mm
Max bevel range	48 - 48°
No Load Speed	4400 rpm
Net Weight	30.7 - 31.3 kg

Δεν συμπεριλαμβάνει μπαταρία και φορτιστή  
Does not include battery and charger

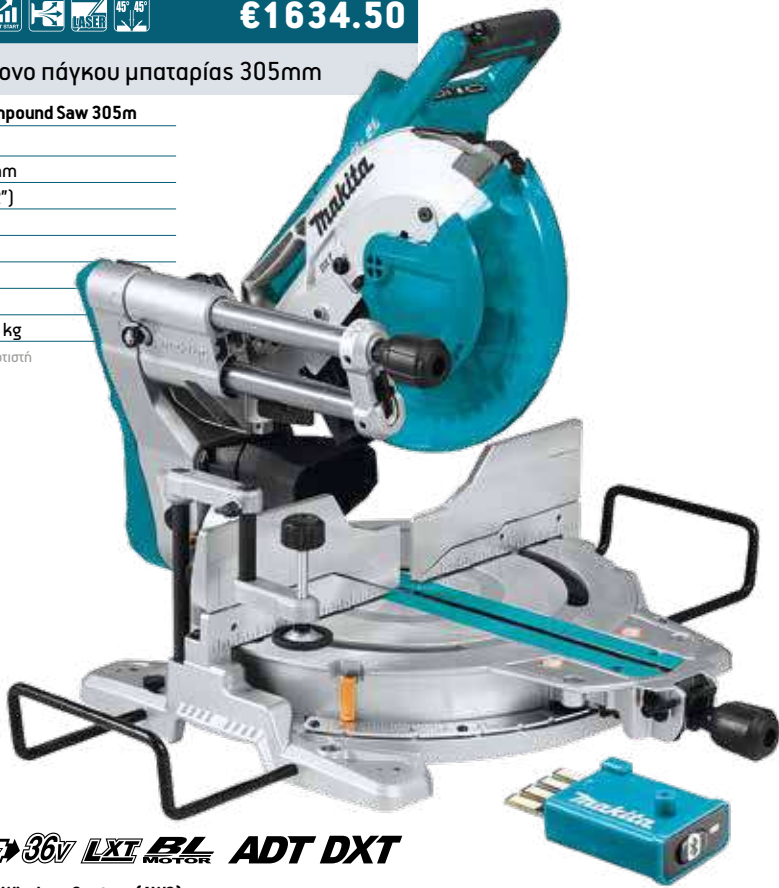

**LITHIUM-ION**  **36V LXT MOTOR ADT DXT**

**AWS**

**Auto-Start Wireless System (AWS)**  
Connects to compatible dust extractors with Bluetooth.





## JV143DWE

€215.00

14.4V Πριόνι

14.4V Jigsaw

Max in Steel	6 mm
Max in Wood	65 mm
No Load Speed	0 - 2,900 spm
Net Weight	1.9kg

Συμπεριλαμβάνει δύο μπαταρίες και φορτιστή  
Includes two batteries and charger

**LITHIUM-ION LXT G5SERIES**



## DJV180Z

€222.00

18V Πριόνι

18V Jigsaw

Max in Steel	10 mm
Max in Wood	135 mm
No Load Speed	0-2600 spm
Net Weight	2.7 - 3.0 kg

Δεν συμπεριλαμβάνει μπαταρία και φορτιστή  
Does not include battery and charger

**LITHIUM-ION LXT**



## DJV181Z

€359.00

18V Πριόνι

18V Brushless Jigsaw

Max in Steel	10 mm
Max in Wood	135 mm
Max in Aluminium	20 mm
Stroke Length	26 mm
No Load Speed	800 - 3,500 spm
Net Weight	2.3 - 2.6 kg

Δεν συμπεριλαμβάνει μπαταρία και φορτιστή  
Does not include battery and charger

**BL MOTOR LITHIUM-ION LXT**



## Jigsaw Blades

Find in accessories section



## DJV182Z

€371.00

18V Πριόνι 135 mm

18V Brushless Jigsaw 135 mm

Max in Steel	10 mm
Max in Wood	135 mm
Max in Aluminium	20 mm
Stroke Length	26 mm
No Load Speed	800 - 3,500 spm
Net Weight	2.4 - 2.7 kg

Δεν συμπεριλαμβάνει μπαταρία και φορτιστή  
Does not include battery and charger

**BL MOTOR LITHIUM-ION LXT**



## DPJ180Z

€321.50

18V Φρεζοκαβιθιέρα (Μπισκοτιέρα)

18V Biscuit Jointer

Blade Diameter	100 mm
Blade Thickness	4 mm
Hole Diameter	22 mm
No Load Speed	6,500 rpm
Net Weight	2.8 - 3.1 kg

Δεν συμπεριλαμβάνει μπαταρία και φορτιστή  
Does not include battery and charger

**LITHIUM-ION LXT**



## DSD180Z

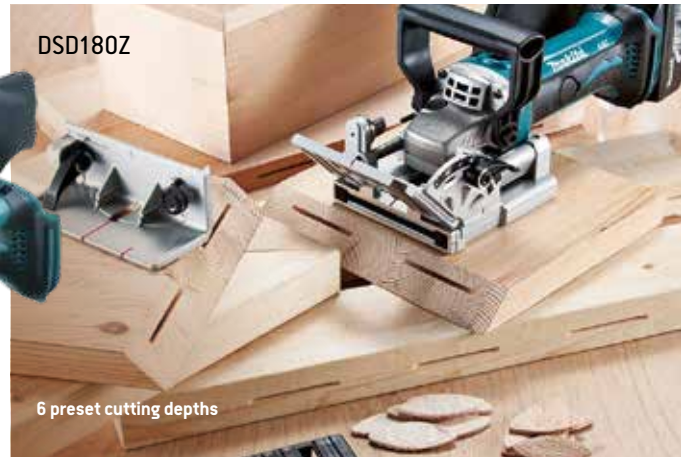

6 preset cutting depths

## DP0600Z

€520.00

18V Στιλβωτήρας (ποηισιέρα) 150mm

18V Brushless Random orbit polisher 150mm

Orbit Diameter	5.5 mm
Pad Size	150 mm
Orbits per minute	0 - 6,800 / Normal / Finishing 0 - 5,200 rpm
Strokes per minute	0 - 13,600 / Normal / Finishing 0 - 10,400 spm
No load speed	0 - 780 / Normal / Finishing 0 - 600 rpm
Net Weight	3.1-3.6 kg

Δεν συμπεριλαμβάνει μπαταρία και φορτιστή  
Does not include battery and charger

**BL MOTOR LITHIUM-ION LXT**



## DP0600Z



## CC301DWAE



## CC301DWAE

€350.00

12V Max Κόφτης κεραμικού/γυαλιού

12V Max Tile Cutter

Blade Diameter	85 mm
Max Cut @ 90°	25,5 mm
Max Cut @ 45°	16,5 mm
Bore Diameter	15 mm
Tank Capacity	0,5 L
No Load Speed	1600 min <sup>-1</sup>
Net Weight	1.5 kg

Συμπεριλαμβάνει δύο μπαταρίες και φορτιστή  
Includes two batteries and charger

**LITHIUM-ION 12V<sub>max</sub> CXT**



## DCC500Z

€315.00

18V Κόφτης Κεραμικού 125mm

18V Brushless Disc Cutter 125mm

Blade Diameter	125 mm
Max Cut @ 0°	40 mm
Bore Diameter	20 mm
No Load Speed	8,800 rpm
Net Weight	2.5 - 3.0 kg

Δεν συμπεριλαμβάνει μπαταρία και φορτιστή  
Does not include battery and charger

**BL MOTOR LITHIUM-ION LXT AWS ADT**



## DCC500 & CC301 wheels & accessories

NEW

Find in accessories section



## JR103DWAE €275.00

12V Πριόνι

12V Reciprocating Saw

Max in Wood	50 mm
Max in Mild Steel Pipe	50 mm
Stroke Length	13 mm
No Load Speed	0 - 3300 spm
Net Weight	1.3 - 1.5 kg

Συμπεριλαμβάνει δύο μπαταρίες και φορτιστή  
Includes two batteries and charger

**LITHIUM-ION** 12V<sub>max</sub> **CXT**



## DJR183Z €154.00

18V Πριόνι

18V Reciprocating Saw

Max in Wood	50 mm
Max in Mild Steel Pipe	50 mm
Stroke Length	13 mm
No Load Speed	0 - 3300 spm
Net Weight	1.5 - 1.7 kg

Δεν συμπεριλαμβάνει μπαταρία και φορτιστή  
Does not include battery and charger

**LITHIUM-ION**



## DJR186Z CB441 €205.00

18V Πριόνι

18V Reciprocating Saw

Max in Wood	255 mm
Max in Mild Steel Pipe	130 mm
Stroke Length	32 mm
No Load Speed	0 - 2,800 spm
Net Weight	3.5 - 3.8 kg

Δεν συμπεριλαμβάνει μπαταρία και φορτιστή  
Does not include battery and charger

**LITHIUM-ION**



## DJR187Z €324.50

18V Πριόνι

18V Brushless Reciprocating Saw

Max in Wood	255 mm
Max in Mild Steel Pipe	130 mm
Stroke Length	32 mm
No Load Speed	0- 3,000 / 0- 2,300 spm
Net Weight	3.4 - 3.8 kg

Δεν συμπεριλαμβάνει μπαταρία και φορτιστή  
Does not include battery and charger

**BL MOTOR** **LITHIUM-ION**



## DJR188Z €246.00

18V Πριόνι

18V Reciprocating Saw 50mm

Max in Wood	255 mm
Max in Mild Steel Pipe	130 mm
Stroke Length	20 mm
No Load Speed	0- 3,000
Net Weight	2.6 - 2.8

Δεν συμπεριλαμβάνει μπαταρία και φορτιστή  
Does not include battery and charger

**BL MOTOR** **LITHIUM-ION**



## DJR189Z €304.00

18V Πριόνι

18V Reciprocating Saw

Max in Wood	255 mm
Max in Mild Steel Pipe	130 mm
Stroke Length	20 mm
No Load Speed	0- 3,000 spm
Net Weight	2.2 - 2.5 kg

Δεν συμπεριλαμβάνει μπαταρία και φορτιστή  
Does not include battery and charger

**BL MOTOR** **LITHIUM-ION** **LXI** **XPT**



## Reciprocating Saw Blades

Find in accessories section 



**DTM51Z**



**€219.50**

18V Ποδηγεραθείο

18V Cordless multi-tool

Shank	Ø18
Oscillation Angle	3.2°
Oscillations per Minute	6,000 - 20,000
Net Weight	2.0 - 2.4 kg

Δεν συμπεριλαμβάνει μπαταρία και φορτιστή  
Does not include battery and charger

**LITHIUM-ION**



**DTM52Z**



**€335.00**

18V Ποδηγεραθείο

18V Cordless multi-tool

Oscillation Angle	3.6°
Oscillations per Minute	10,000 - 20,000
Max Output	370W
Net Weight	1.7 - 2.0 kg

Δεν συμπεριλαμβάνει μπαταρία και φορτιστή  
Does not include battery and charger

**BL MOTOR LITHIUM-ION STARLOCK**

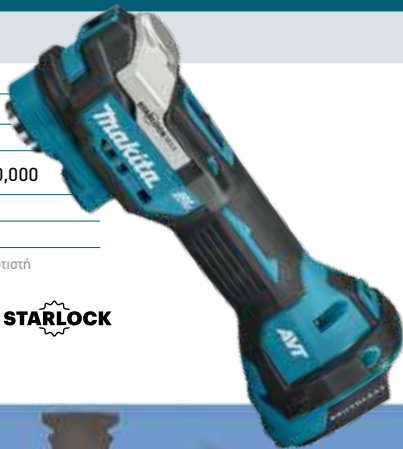

DTM52Z



**STARLOCK**



# X LOCK

## QUICK & EFFORTLESS WHEEL CHANGE SYSTEM

JUST **SNAP-IN**



JUST **PULL IT**



**DGA452Z**  **€130.00**

18V Σμυρίδιος 115mm

18V Angle grinder 115mm

Max Wheel Diameter	115 mm
No Load Speed	10,000 rpm
Net Weight	2.06- 2.71 kg

Δεν συμπεριλαμβάνει μπαταρία και φορτιστή  
Does not include battery and charger

**LITHIUM-ION LXT**



**DGA454Z**     **€226.00**

18V Σμυρίδιος 115mm

18V Angle grinder 115mm

Bore Diameter	22.23 mm
Max Wheel Diameter	115 mm
No Load Speed	8,500 rpm
Net Weight	1.9 kg

Δεν συμπεριλαμβάνει μπαταρία και φορτιστή  
Does not include battery and charger

**BL MOTOR LITHIUM-ION LXT ADT XPT**



**DGA463Z**    **€251.00**

18V Σμυρίδιος 115mm

18V Angle grinder 115mm

Bore Diameter	22.23 mm
Max Wheel Thickness	7.2 mm
Max Wheel Diameter	115 mm
No Load Speed	3,000 - 8,500 rpm
Net Weight	2.3 - 3.0 kg

Δεν συμπεριλαμβάνει μπαταρία και φορτιστή  
Does not include battery and charger

**BL MOTOR LITHIUM-ION LXT AFT ADT**



**DGA513Z**    **€245.00**

18V Σμυρίδιος 125mm

18V Angle grinder 125mm

Bore Diameter	22.23 mm
Max Wheel Thickness	7.2 mm
Max Wheel Diameter	125 mm
No Load Speed	3,000 - 8,500 rpm
Net Weight	2.4 - 3.0 kg

Δεν συμπεριλαμβάνει μπαταρία και φορτιστή  
Does not include battery and charger

**BL MOTOR LITHIUM-ION LXT AFT ADT**



**DGA469Z**    **€352.00**

18V Σμυρίδιος 115mm

18V Angle grinder 115mm

Bore (B)	22.23 mm
Max Wheel Thickness	6 mm
Max Wheel Diameter	115 mm
No Load Speed	3,000 - 8,500 rpm
Net Weight	2.5 - 3.1 kg

Δεν συμπεριλαμβάνει μπαταρία και φορτιστή  
Does not include battery and charger

**BL MOTOR LITHIUM-ION LXT AWS ADT XLOCK**



**DGA519Z**    **€299.00**

18V Σμυρίδιος 125mm

18V Angle grinder 125mm

Bore (B)	22.23 mm
Max Wheel Thickness	6 mm
Max Wheel Diameter	125 mm
No Load Speed	3,000 - 8,500 rpm
Net Weight	2.5 - 3.1 kg

Δεν συμπεριλαμβάνει μπαταρία και φορτιστή  
Does not include battery and charger

**BL MOTOR LITHIUM-ION LXT AWS ADT XLOCK**



**Dust Collecting Cap for angle grinders**

Find in accessories section



**DGA900Z**   **€470.00**

36 (18V x2) V Σμυρίδιος 230mm

36 (18V x2) Brushless Angle grinder 230mm

Bore (B)	22.23 mm
Max Wheel Thickness	6.5 mm
Max Wheel Diameter	230 mm
No Load Speed	6,000 rpm
Net Weight	5.2 - 8.0 kg

Δεν συμπεριλαμβάνει μπαταρία και φορτιστή  
Does not include battery and charger

**LITHIUM-ION 18V x2 36V LXT BL MOTOR AFT ADT**



**DGD800Z****€215.00**

18V Λειαντήρας ίσιος 6mm

18V Die grinder 6mm

Collet Capacity	6 mm
No Load Speed	25,000 rpm
Net Weight	1.7 kg

Δεν συμπεριλαμβάνει μπαταρία και φορτιστή  
Does not include battery and charger**LITHIUM-ION LXT****DJN161Z****€511.00**

18V Κόφτης Λαμαρίνας 1.6 mm

18V Nibbler 1.6 mm

Max in mild steel	1.6 mm
Max in stainless steel	1.2 mm
Max in aluminium	2.5 mm
Strokes per Minute	1,900 spm
Min Cutting Outside Edge	50 mm
Radius Inside Edge	45 mm
Net Weight	1.9 - 2.3 kg

Δεν συμπεριλαμβάνει μπαταρία και φορτιστή  
Does not include battery and charger**LITHIUM-ION LXT****DCE090ZX1****€927.00**

36 (18V x2) V Κόφτης δομικών υλικών 230mm

36 (18V x2) Brushless Power cutter 230mm

Max. Cutting Depth	88 mm
Bore (B)	22.23 mm
Max Wheel Thickness	3.0 mm
Max Wheel Diameter	230 mm
No Load Speed	6,600 rpm
Net Weight	5.6 - 6.3 kg

Δεν συμπεριλαμβάνει μπαταρία και φορτιστή  
Does not include battery and charger**BL MOTOR LITHIUM-ION 18V x2 36V LXT AFT**

DUT130Z

**DUT130Z****€355.00**

18V Αναδευτήρας

18V Brushless Mixer

Max Paddle Diameter	165 mm
Spindle Size	M14
No Load Speed	0 - 1300 / 350 rpm
Net Weight	2.5 - 2.8 kg

Δεν συμπεριλαμβάνει μπαταρία και φορτιστή  
Does not include battery and charger**BL MOTOR LITHIUM-ION LXT****DGP180Z****€304.00**

18V Γρασέρα

18V Grease Gun

Grease Capacity (Cartridge)	410 g
Grease Capacity (Bulk)	455 g
Flexible Hose Length	1,200 mm
Max operating pressure	10,000 psi
Flow rate (Auto speed change)	290 ml/min
Net Weight	4.8 - 6.1 kg

Δεν συμπεριλαμβάνει μπαταρία και φορτιστή  
Does not include battery and charger**LITHIUM-ION LXT****DCG180ZBK****€406.00**

18V Πιστόλι Σιλικόνης 600ml

18V Mobile caulking gun 600ml

Max. Push Force	5000 N
No Load Speed	0-28 mm/sec
Net Weight	2.6 - 3.0 kg

Δεν συμπεριλαμβάνει μπαταρία και φορτιστή  
Does not include battery and charger**LITHIUM-ION LXT**

Holders

Find in accessories section



## DMP180Z

€115.00

### 18V Κομπρεσοράκι

#### 18V Inflator

Air Discharge Amount	12 litres/min
Max Air Pressure	830 kPa
Net Weight	1.4 - 1.7 kg

Δεν συμπεριλαμβάνει μπαταρία και φορτιστή  
Does not include battery and charger

**LITHIUM-ION LXT**



### Air Valve Adapter Heads

Find in accessories section

NEW



## DTR180ZK

€1121.00

### 18 Εργαλείο Δεσίματος Οικοδομικού Σιδήρου

#### 18V Brushless Rebar Tying Tool

Tie Wire	0.8 mm
Applicable Rebars	D10 x D10 - (D13 x2) x (D13 x2)
Approximate ties per reel	120 (with BL1850B)
Net Weight	2.3 - 2.6 kg

Συμπεριλαμβάνει θήκη μεταφοράς  
Includes carrying case

Δεν συμπεριλαμβάνει μπαταρία και φορτιστή  
Does not include battery and charger

**BL MOTOR LITHIUM-ION LXT XPT**



### Steel Tie Wire

### Extension Handle

Find in accessories section

NEW



## DSC251ZK ΜΟΝΟ ΜΕ ΠΑΡΑΓΓΕΛΙΑ ORDER ONLY

€1545.00

### 18V Κόφτης Ατσάλινων Ράβδων

#### 18V Brushless Steel Rod Cutter

Blade Diameter	110 mm
No Load Speed	2,200 rpm
Cutting Capacity (Rebar)	10-25 mm
Net Weight	3.9 - 4.0 kg

Συμπεριλαμβάνει θήκη μεταφοράς  
Includes carrying case

Δεν συμπεριλαμβάνει μπαταρία και φορτιστή  
Does not include battery and charger

**BL MOTOR LITHIUM-ION LXT ADT**

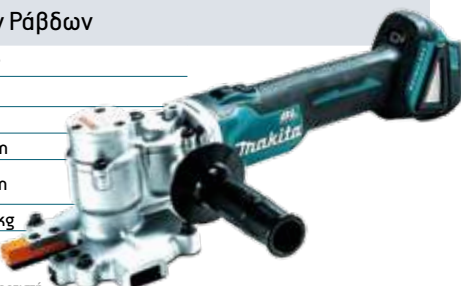

## SC103DZ



## SC103DZ

€905.00

### 12V Max Κόφτης Μεταλλικών Ράβδων

#### 12V Max Brushless Threaded Rod Cutter

Min. Cutting Length	20 mm
Max. cutting capacities	
Mild Steel	W3/8, M10, M8, M6
Stainless Steel	W3/8, M8, M6
Overall Length	180mm
Net Weight	2.4kg

Δεν συμπεριλαμβάνει μπαταρία και φορτιστή  
Does not include battery and charger

**BL MOTOR LITHIUM-ION 12Vmax CXT**



## CP100DSM

€253.00

### 12V Max Πολυκόφτης 6mm

#### 12V Max Multi Cutter 6mm

Cutting Capacity	6 mm
No Load Speed	300 rpm
Net Weight	0.72 - 0.88 kg

Συμπεριλαμβάνει μία μπαταρία 4.0Ah και φορτιστή  
Includes one battery 4.0Ah and charger

**LITHIUM-ION 12Vmax CXT**



## DSC191Z

€3574.00

### 18V Κόφτης Ατσάλινων Ράβδων

#### 18V Steel Rebar Cutter

Blade Diameter	110 mm
No Load Speed	2,200 rpm
Cutting Capacity (Rebar)	10-25 mm
Net Weight	3.9 - 4.0 kg

Συμπεριλαμβάνει θήκη μεταφοράς  
Includes carrying case

Δεν συμπεριλαμβάνει μπαταρία και φορτιστή  
Does not include battery and charger

**BL MOTOR LITHIUM-ION LXT ADT**



## DSC191Z ΕΙΔΙΚΗ ΤΙΜΗ SPECIAL PRICE

€3574.00

### 18V Κόφτης Ατσάλινων Ράβδων

#### 18V Steel Rebar Cutter

Cutting time	6,5 s
Cutting Capacity Mild Steel (up to 400N/mm <sup>2</sup> )	20 mm
Cutting Capacity Stainless Steel (up to 600N/mm <sup>2</sup> )	20 mm
Net Weight	11,1-11,2 kg

Συμπεριλαμβάνει θήκη μεταφοράς  
Includes carrying case

Δεν συμπεριλαμβάνει μπαταρία και φορτιστή  
Does not include battery and charger

**LXT**





**Makita**<sup>®</sup>

**FASTER.  
STRONGER.  
TOUGHER.**

**DVP180Z** ΕΙΔΙΚΗ ΤΙΜΗ SPECIAL PRICE **€519.00**

18V Απορροφητική αντλία ψυκτικού συστήματος

18V Vacuum Pump

Compression type	Oil rotary type (vane type), Single stage
Flow rate	50 litres/min
Inlet port	5/16"
Motor speed	3,840 rpm
Oil Capacity	115 ml
Ultimate Vacuum	20 Pascals
Net Weight	3.5 kg

Δεν συμπεριλαμβάνει μπαταρία και φορτιστή  
Does not include battery and charger

**LITHIUM-ION LXT**



**DHW080ZK** **2** **€720.00**

36 (18V x2) V Πλυστικό Υψηλής Πίεσης

36 (18V x2) Brushless Power Washer

Temperature	0 - 40 °
Tank Capacity	50 litres
Pump Speed (Hi/Lo Pressure)	3,450 / 2,390 rpm
Regular Pressure (Hi/Lo setting)	55 / 30 bar
Max Permissible Pressure	80 bar
Regular Flow (Hi/Lo Pressure)	330 / 240 l/hr
Max Water Flow	380 l/hr
Net Weight	6.4 - 7.7 kg

Συμπεριλαμβάνει θάκη  
Includes case

Δεν συμπεριλαμβάνει μπαταρία και φορτιστή  
Does not include battery and charger

**BL MOTOR LITHIUM-ION 18V x 2 36V LXT**



Power Washer Accessories

Find in accessories section



## DCL180Z / B

€102.00 Z /  
74.00 ZB

18V Απορροφητική Σκούπα

18V Vacuum Cleaner

Capacity	0.65 litres
Max Sealed Suction	3.6 kPa
Max Airflow	1.3 m <sup>3</sup> /min
Net Weight	1.2 kg

Δεν συμπεριλαμβάνει μπαταρία και φορτιστή  
Does not include battery and charger

**LITHIUM-ION LXT**

DCL180Z

DCL180ZB



DCL184Z

Blower function  
Range of nozzles available  
Ideal for interior car cleaning

## DCL280FZ

€181.00

18V Απορροφητική Σκούπα

18V Brushless Vacuum Cleaner

Suction Power (DC)	45 W
Capacity	0.75 litres
Max Sealed Suction	6.4 kPa
Max Airflow	1.4 m <sup>3</sup> /min
Net Weight	1.4 kg

Δεν συμπεριλαμβάνει μπαταρία και φορτιστή  
Does not include battery and charger

**BL MOTOR LITHIUM-ION LXT**

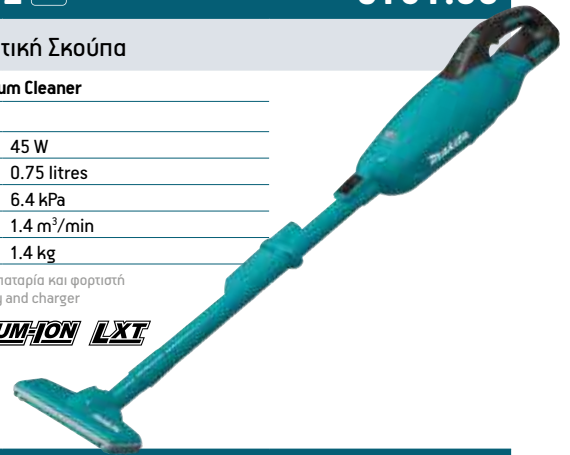

## DCL184Z

€160.00

18V Απορροφητική Σκούπα

18V Brushless Vacuum Cleaner

Dust Capacity	
Cloth dust bag	550 ml
Paper dust bag	330 ml
Suction Power (DC)	38 W
Max Airflow	1.4 m <sup>3</sup> /min
Max Sealed Suction	5.4 kPa
Net Weight	1.8 kg

Δεν συμπεριλαμβάνει μπαταρία και φορτιστή  
Does not include battery and charger

**BL MOTOR LITHIUM-ION LXT**



## DVC261ZX11

€546.00

36 (18V x2) V Σκούπα Πλάτης

36 (18V x2) Brushless Backpack Vacuum Cleaner

Dust Capacity	
Cloth dust bag	1.5 litres
Paper dust bag	2.0 litres
Suction Power (DC)	105 W
Max Airflow	2.3 m <sup>3</sup> /min
Max Sealed Suction	11 kPa
Net Weight	3.8 - 4.5 kg

Δεν συμπεριλαμβάνει μπαταρία και φορτιστή  
Does not include battery and charger

**BL MOTOR LITHIUM-ION 18V x2 LXT**



DVC261ZX11



DVC350Z



Blower function  
Shoulder belt can be easily slung over your shoulder for added mobility

## DVC350Z

€303.00

18V Απορροφητική Σκούπα

18V Vacuum Cleaner

Capacity dust bag	3 litres
Max air velocity	94 m/sec
Max Airflow	3.4 m <sup>3</sup> /min
Max Sealed Suction	5.5 kPa

Run Time  
LOW 43min/BL1850  
HIGH 22min/BL1850

Net Weight  
2.2 - 2.4 kg

Δεν συμπεριλαμβάνει μπαταρία και φορτιστή  
Does not include battery and charger

**LITHIUM-ION LXT**



## DVC660Z €497.00

36 (18V x2) V Σκούπα Πλάτης

36 (18V x2) Brushless Backpack Vacuum Cleaner

Dust Capacity

Cloth dust bag 5.5 litres

Paper dust bag 6.0 litres

Suction Power (DC) 95 W

Max Airflow 2.2 m<sup>3</sup>/min

Max Sealed Suction 11 kPa

Net Weight 6.1 - 6.7 kg

Δεν συμπεριλαμβάνει μπαταρία και φορτιστή  
Does not include battery and charger

**BL MOTOR LITHIUM-ION 18V x2 36V LXT**



DRC200Z

## DRC200Z ΜΟΝΟ ΜΕ ΠΑΡΑΓΓΕΛΙΑ ORDER ONLY €1486.00

18V Ρομποτική Σκούπα

18V Brushless Robotic Vacuum Cleaner

Continuous Run Time (2 x 5.0Ah) 200 mins approx

Max Cleaning Area (5.0Ah x2) 500 m<sup>2</sup>

Running Speed 0.3 m/sec

Dust Capacity 2.5 litres

Net Weight 7.8 kg

Δεν συμπεριλαμβάνει μπαταρία και φορτιστή  
Does not include battery and charger

**BL MOTOR LITHIUM-ION 18V x2 36V LXT AWS**



## SK105GDZ

€652.00

12V Max Λείζερ Πράσινος Δέσμος

12V Max Green cross-line laser

Weight	0,70kg
Self leveling	±4°
Range	35m

Δεν συμπεριλαμβάνει μπαταρία και φορτιστή  
Does not include battery and charger

**LITHIUM-ION 12V<sub>max</sub> CXT**



## SK105DZ

€291.00

12V Max Λείζερ Κόκκινος Δέσμος

12V Max Red cross-line laser

Weight	0,70kg
Self leveling	±4°
Range	25m

Δεν συμπεριλαμβάνει μπαταρία και φορτιστή  
Does not include battery and charger

**LITHIUM-ION 12V<sub>max</sub> CXT**



## SK700GDZ

€995.00

12V Max Λείζερ Πράσινος Δέσμος

12V Max Green multi-line laser

Weight	0.99-1.2kg
Self leveling	±4°
Beam Direction / fan angle	2x Vertical 360° 1x Horizontal 360°
Range	35m / 70m
Range (with receiver)	70 / 140m

Δεν συμπεριλαμβάνει μπαταρία και φορτιστή  
Does not include battery and charger

**LITHIUM-ION 12V<sub>max</sub> CXT**



SK700GDZ



## DWD181ZJ



ΕΙΔΙΚΗ ΤΙΜΗ  
SPECIAL PRICE

€1817.00

18V Σαρωτής τοίχου

18V Wall Scanner

Weight	1,70kg
--------	--------

Max detection depth:

Metal in concrete	180 mm
Plastic pipe in concrete	120 mm
Wood stud behind drywall	25 mm

Detection accuracy of object:

Centre position	± 5 mm
Depth	± 5 mm

Scene mode selection

Dry concrete

Wet concrete

Radar view mode

Δεν συμπεριλαμβάνει μπαταρία και φορτιστή  
Does not include battery and charger

**LITHIUM-ION LXT**



## CAPACITY

Capable of detecting a variety of embedded objects up to 180mm deep



## APPLICATIONS

Multi-detection mode; ideal for detecting objects running diagonally



## VERSATILITY

Selectable base material modes allow for increased versatility



## CONVENIENCE





Laser guide and LED light combine to allow for straight and clear travel across scanned surface





# DCU180Z WHEELBARROW

- Overload protection
- Electronic 2-speed selection
- Soft start
- Reverse gear
- 3 stage adjustable handle
- Brake lever with locking mechanism
- Folding handle for compact storage
- Rear wheels with stopper
- Width adjustable rear wheels
- Rear wheels can be detached and replaced with standing legs
- LED job light

**DCU180Z**      **€1594.50**

**18V Χειράριμα μπαταρίας**  
**18V Brushless Wheelbarrow**

Forward speed (Hi/Lo)	3.5 / 1.5 km/h
Max climbing angle	12°
Max loading capacity	130 kg
Reverse speed	1.0 km/h
Net Weight	32.5 kg

Δεν συμπεριλαμβάνει μπαταρία και φορτιστή  
Does not include battery and charger

**BL MOTOR LITHIUM-ION LXT**



**Wheelbarrow Accessories**

Find in **accessories** section



# COMBO DEALS

**DLX2537SJ** ΕΙΔΙΚΗ ΤΙΜΗ SPECIAL PRICE **€395.00**

18V Σετ Εργαλείων

18V Combo Kit

DHP490	Cordless Combi Drill
DTD153	Cordless impact driver
BL1830 x 2	Batteries 3.0Ah
DC18RC	Charger
821551-8	Μακpac Type 3

Συμπεριλαμβάνει **τρεις** μπαταρίες και φορτιστή  
Includes **three** batteries and charger



**DLX2537TJ** ΕΙΔΙΚΗ ΤΙΜΗ SPECIAL PRICE **€460.00**

18V Σετ Εργαλείων

18V Combo Kit

DHP490	Cordless Combi Drill
DTD153	Cordless impact driver
BL1850B x 2	Batteries 5.0Ah
DC18RC	Charger
821551-8	Μακpac Type 3

Συμπεριλαμβάνει **τρεις** μπαταρίες και φορτιστή  
Includes **three** batteries and charger



**DLX2131TJ** ΕΙΔΙΚΗ ΤΙΜΗ SPECIAL PRICE **€416.00**

18V Σετ Εργαλείων

18V Combo Kit

DHP482	Cordless hammer driver drill
DTD152	Cordless impact driver
BL1850 x 2	Batteries
DC18RC	Charger
821551-8	Μακpac Type 3

Συμπεριλαμβάνει **δύο** μπαταρίες και φορτιστή  
Includes **two** batteries and charger





## DLX2180TJ ΕΙΔΙΚΗ ΤΙΜΗ SPECIAL PRICE €499.00

18V Σετ Εργαλείων - Brushless LXT

18V Combo Kit - Brushless LXT

DHP484	Cordless hammer driver drill
DTD153	Cordless impact driver
BL1850 x 2	Batteries
DC18RC	Charger
821551-8	Μακpac Type 3

Συμπεριλαμβάνει **δύο** μπαταρίες και φορτιστή  
Includes **two** batteries and charger



## CLX245SAX1 ΕΙΔΙΚΗ ΤΙΜΗ SPECIAL PRICE ΜΕΧΡΙ ΕΞΑΝΤΛΗΣΕΩΣ UNTIL STOCK LASTS €199.00

12V Max Σετ Εργαλείων

12V Max Combo Kit

CL108FDZW	Cordless vacuum cleaner
UB100DZ	Cordless blower
BL1021B	Battery
DC10SB	Charger

Συμπεριλαμβάνει **μία** μπαταρία και φορτιστή  
Includes **one** batteries and charger



## CLX224AJ €278.00

12V Max Σετ Εργαλείων

12V Max Combo Kit

DF333D	Cordless drill driver
TD110D	Cordless impact driver
BL1021B x 2	Batteries (2.0Ah)
DC10WD	Charger
Type 1	Μακpac

Συμπεριλαμβάνει **δύο** μπαταρίες και φορτιστή  
Includes **two** batteries and charger



# ΠΡΟΣΤΑΤΕΥΣΕ ΤΟΝ ΕΑΥΤΟ ΣΟΥ ΑΠΟ ΑΣΘΕΝΕΙΕΣ ΠΟΥ ΣΧΕΤΙΖΟΝΤΑΙ ΜΕ ΚΡΑΔΑΣΜΟΥΣ (ασθένεια λευκών δακτύλων)

## ΤΕΧΝΟΛΟΓΙΑ ΚΑΤΑ ΤΩΝ ΚΡΑΔΑΣΜΩΝ

ANTI VIBRATION TECHNOLOGY

AVT<sup>TM</sup>



### VIBRATION ABSORBING HOUSING

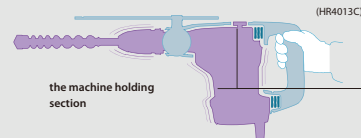

### ACTIVE DYNAMIC VIBRATION ABSORBER

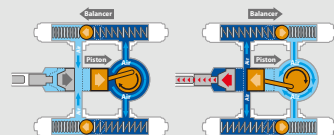

### DAMPER SPRING



Photo : HR4013C (Tool does not come with bit.)

Το σύστημα Anti-vibration διαθέτει ενεργό δυναμικό απορροφητή κραδασμών, ο οποίος εξασφαλίζει λειτουργία με εξαιρετικά χαμηλές δονήσεις.

Τα εργαλεία έχουν σχεδιαστεί με σώμα με επίπεδη όψη, ώστε να είναι πιο εύκολο να χειριστούν.

Το ελατήριο απόσβεσης πίσω από το τρυπάνι απορροφά τη δύναμη αντίδρασης που προκαλείται από το τρυπάνι τη στιγμή της κρούσης.

Το ελατήριο απόσβεσης στη λαβή διαχωρίζει τη λαβή από το σώμα του μηχανήματος, μειώνοντας περαιτέρω τη δόνηση.

**Makita**<sup>®</sup>

**THE FUTURE IS  
POWERFUL**

**XGT**

**40V** *Li-ion*  
**max**



## DF001GM101

€780.00

40V Σετ κατσαβίδι 13mm (1/2")

40V Brushless Set Driver Drill 13mm (1/2")

Capacity in Wood	Auger bit: 50mm, Self-feeding bit: 76mm, Hole saw: 152mm
Capacity in Steel	20mm
Max. lock torque	125Nm
Max. peak torque	141Nm
Max. tightening torque	Hard: 140Nm / Soft: 68Nm
No Load Speed	0 - 2,600 / 650 rpm
Net Weight	2.0kg

Συμπεριλαμβάνει μία μπαταρία (4Ah) φορτιστή και πλαστική θήκη μεταφοράς  
Includes one battery (4Ah) and charger and plastic carrying case



**XGT** **BL** **LITHIUM-ION** **XPT** **AFT**

## DF001GZ

€375.00

Εργαλείο μόνο

Tool only

## KP001GZ



ANTI-RESTART  
FUNCTION

€530.50

40V Πλάνη

40V Planer

Planing Width	82 mm
Max. Chip Thickness (Planing Depth)	0-4 mm
Max. Shipping Depth	25 mm
Vacuum cleaner connection	in / out: 45/50 mm
No Load Speed	15000 min <sup>-1</sup>
Net Weight	2,5 kg



Bluetooth technology for wireless power-on and power-off communication between the equipped tool and dust extractor.



**XGT** **BL** **LITHIUM-ION** **AWS**

## HP001GM201



€1126.00

40V Σετ κρουστικό τράπανο 13mm (1/2")

40V Brushless Set impact driver drill 13mm (1/2")

Capacity in Steel	20mm
Capacity in Wood	76 mm
Capacity in Masonry	20 mm
Blows per Minute	0 - 39,000 / 9,750 ipm
No Load Speed	0 - 2,600 / 650 rpm
Net Weight	2.7kg

Συμπεριλαμβάνει δύο μπαταρίες (4Ah) φορτιστή και πλαστική θήκη μεταφοράς  
Includes two batteries (4Ah) and a charger and plastic carrying case



**XGT** **BL** **LITHIUM-ION** **XPT** **AVT** **AFT**

## HP001GZ01

€381.00

Εργαλείο μόνο

Tool only

## PV001GZ



ANTI-RESTART  
FUNCTION

€553.00

40V Ποηισιέρα 180 mm

40V Polisher 180 mm

Planing Width	82 mm
No Load Speed	600 - 2200 min <sup>-1</sup>
Net Weight	2,3 kg

**XGT** **BL** **LITHIUM-ION** **XPT**



## AS001GZ €281.00

40V Max Φυσητήρας Σκόνης

40V Max Dust Blower

Blowing Force	2.8N
Max. Air Velocity	200m/sec
Max. Air Volume	1.1m <sup>3</sup> /min
Max. sealed suction	10.3kPa
Net Weight	0.9kg



**XGT** **BL** **LITHIUM-ION** MOTOR



## GA004GM101 €694.00

40V Σετ σμυρίδιος 115mm (4 1/2")

40V Brushless Set angle grinder 115mm (4 1/2")

Bore Diameter	22.23 mm
Max Wheel Thickness	7.2 mm
Max Wheel Diameter	115 mm
No Load Speed	8,500 rpm
Net Weight	2.9 – 3.6 kg

Συμπεριλαμβάνει μία μπαταρία (4Ah) φορτιστή και πλαστική θήκη μεταφοράς  
Includes one battery (4Ah) and charger and plastic carrying case



**XGT** **BL** **LITHIUM-ION** MOTOR **XPT** **AFT**

## GA004GZ €291.00

Εργαλείο μόνο

Tool only

## GA022GZ01 €356.00

40V Σμυρίδιος 115mm (4 1/2")

40V Brushless angle grinder 115mm (4 1/2")

Bore Diameter	22.23 mm
Max Wheel Thickness	7.2 mm
Max Wheel Diameter	115 mm
No Load Speed	3,000 - 8,500 rpm
Net Weight	2.9 – 3.6 kg

**AWS** 

Bluetooth technology for wireless power-on and power-off communication between the equipped tool and dust extractor.

Δεν συμπεριλαμβάνει μπαταρία και φορτιστή  
Does not include battery and charger

FORWARD  
MAX  
350  
N.m  
REVERSE



**XGT** **BL** **LITHIUM-ION** MOTOR **XPT** **AFT** **AWS**

## GA005GM201 €1051.00

40V Σετ σμυρίδιος 125mm

40V Brushless Set angle grinder 125mm

Bore Diameter	22.23 mm
Max Wheel Thickness	7.2 mm
Max Wheel Diameter	125 mm
No Load Speed	8,500 rpm
Net Weight	2.9 – 3.6 kg

Συμπεριλαμβάνει δύο μπαταρίες (4Ah) φορτιστή και πλαστική θήκη μεταφοράς  
Includes two batteries (4Ah) and a charger and plastic carrying case



**XGT** **BL** **LITHIUM-ION** MOTOR **XPT** **AFT**

## GA005GZ01 €369.00

Εργαλείο μόνο

Tool only

## HR003GM101 €933.50

40V Σετ SDS-Plus κρουστικό περιστροφικό τράπανο 28mm

40V Brushless Set SDS-Plus combination hammer 28mm

Max in concrete	28 mm	Max in steel	13 mm
Max in wood	32 mm	Impact energy	2.8 J
Shank	SDS PLUS	Optimum Drilling Range	4 - 16 mm
Max in concrete (TCT core)	54 mm	Max in concrete (Diamond core)	65 mm
Blows per minute	0 - 5,000 bpm	No Load Speed	0 - 980 rpm
Net Weight	3.9 - 4.6 kg		

Συμπεριλαμβάνει μία μπαταρία (4Ah) φορτιστή και πλαστική θήκη μεταφοράς  
Includes one battery (4Ah) and charger and plastic carrying case



**XGT** **BL** **LITHIUM-ION** **XPT** **AVT**

## HR003GZ01 €547.50

Εργαλείο μόνο

Tool only

## HR007GM101 €832.00

40V Σετ κρουστικό τράπανο

40V Brushless combination hammer

Max in concrete	28 mm	Max in steel	13 mm
Max in wood	32 mm	Impact energy	3.0 J
Impacts Per Minute (ipm)	0 - 5000	Optimum Drilling Range	10 - 18 mm
Max in concrete (TCT core)	54 mm	No Load Speed	0 - 980 rpm
Blows per minute	0 - 5,000 bpm		
Net Weight	2.9 kg		

Συμπεριλαμβάνει μία μπαταρία (4Ah) φορτιστή και πλαστική θήκη μεταφοράς  
Includes one battery (4Ah) and charger and plastic carrying case



**XGT** **BL** **LITHIUM-ION** **AVT** **AFT** **AWS**

## HR007GZ €441.00

Εργαλείο μόνο

Tool only

## JR001GM101 €772.00

40V Σετ Πριόνι 255mm

40V Brushless Set Recipro saw 255mm

Max in wood	255 mm
Max in Mild Steel Pipe	130 mm
Stroke Length	32 mm
Strokes per Minute	0 - 3,000 / 0 - 2,300 spm
Net Weight	4.2 - 4.5 kg

Συμπεριλαμβάνει μία μπαταρία (4Ah) φορτιστή και πλαστική θήκη μεταφοράς  
Includes one battery (4Ah) and charger and plastic carrying case



**XGT** **BL** **LITHIUM-ION** **XPT**

## JR001GZ €351.00

Εργαλείο μόνο

Tool only

## TD001GM201 €1126.00

40V Σετ παλμικό κατσαβίδι 6.35mm (1/4")

40V Brushless Set impact driver 6.35mm (1/4")

Max Torque (Nm)	220
No Load Speed (RPM)	
Max:	0-3700 / H: 0-3200 / M: 0-2100 / S: 0-1100
Impacts Per Minute (ipm)	
Max:	0-4400 / H: 0-3600 / M: 0-2600 / L: 0-1100
Net Weight	1.7 kg

Συμπεριλαμβάνει δύο μπαταρίες (4Ah) φορτιστή και πλαστική θήκη μεταφοράς  
Includes one battery (4Ah) and charger and plastic carrying case



**XGT** **BL** **LITHIUM-ION** **XPT**

## TD001GZ02 €310.00

Εργαλείο μόνο

Tool only

**TW001GM101**     **€971.00**

40V Σετ παλμικός βιδολόγος 3/4"

40V Brushless Set impact wrench 3/4"

Max Nut Busting Torque	2,050Nm
Max Fastening Torque	1,800Nm
Impact Power Selection	Max/Hard/Med/Soft
No Load Speed	0 - 1,800/ 1,400/ 1,150/ 950 rpm
Blows per Minute	0 - 2,400/ 2,200 /1,900 ipm
Driving Shank	3/4" Square (C-ring)
Net Weight	3.9-4.2kg

Συμπεριλαμβάνει μία μπαταρία (4Ah) φορτιστή και πλαστική θήκη μεταφοράς  
Includes one battery (4Ah) and charger and plastic carrying case



**XGT** **BL** MOTOR **LITHIUM-ION** **XPT**

**TW001GZ01** **€517.00**

Εργαλείο μόνο

Tool only



**TW004GZ**     **€356.00**

40V Παλμικός βιδολόγος 1/2"

40V Brushless Set impact wrench 1/2"

Max Nut Busting Torque	630 Nm
Max Fastening Torque	350 Nm
Impact Power Selection	Max/Hard/Med/Soft
No Load Speed	0 - 3,200/ 2,600/ 1,800/ 1,000 rpm
Blows per Minute	0 - 3,400/ 2,600 /1,800 ipm
Driving Shank	1/2" Square Drive (C-ring)
Net Weight	1.9 - 2.2 kg

Δεν συμπεριλαμβάνει μπαταρία και φορτιστή  
Does not include battery and charger



**XGT** **BL** MOTOR **LITHIUM-ION** **XPT**



**HS004GM101****€945.00**

40V Σετ δισκοπρίονο 190mm

40V Brushless Set circular saw 190mm

Max Cut @ 0°	60 mm
Max Cut @ 48°	41 mm
Max Cut @ 45°	43 mm
Blade Diameter	190 mm
No Load Speed	6,000 rpm
Net Weight	4.4 – 4.7 kg

Συμπεριλαμβάνει μία μπαταρία (4Ah)  
φορτιστή και ηλκαστική θήκη μεταφοράς  
Includes one battery (4Ah) and charger  
and plastic carrying case

**XGT BL LITHIUM-ION XPT ADT****HS004GZ****€484.00**

Εργαλείο μόνο

Tool only

**LS003GZ01****€1493.00**

40V Σετ δισκοπρίονο πάγκου 305mm

40V Brushless Slide Compound Saw 305mm

Max Cut @ 0°	Max. width: 92x382mm Max. height: 107x363mm
Max Cut @ 45°	Max. width: 71 x 363 / 61 x 382 mm
Blade diameter	305mm (12")
Max mitre range	60 - 60°
Bore Diameter	30 mm
Max bevel range	48 - 48°
No Load Speed	3,600 rpm
Net Weight	28,9 kg

**XGT BL LITHIUM-ION DXT AWS****LS003GZ****€750.00**

Εργαλείο μόνο

Tool only



**XGT X2**

**CE001GZ**    **80V<sub>max</sub>** €1251.50

80V Max (40Vx2) Κόφτης δομικών υλικών

80V Max (40Vx2) Brushless Power Cutter

Max. Cutting Depth	127mm
Wheel diameter	355mm
Bore Diameter	25,4 mm
Overall Length	786mm
No Load Speed	5,300rpm
Net Weight	10.3kg



**XGT** **BL** **LITHIUM-ION** **AFT** **WG** **XPT**

**AFT**

**Active Feedback sensing Technology (AFT)**  
Shuts down current to the motor to protect user, if the rotation speed suddenly slows down (in the case of kick-back, etc.).

**WG** / **IPX4**

**XPT**

**High water-resistance**  
Allows to operate the machine even if it is wet with water.

**eXtreme Protection Technology**  
Enhanced Dust and Drip-proof. Performance ensure reliable operation even under bad weather.

### LOW VIBRATION

Extra-low vibration level for reduced operator fatigue

### ELECTRIC BRAKE

Quickly stops the wheel rotation after the switch has been disengaged

### 40VX2 BRUSHLESS

Delivers powerful performance exceeding that of petrol alternatives whilst eliminating noise and fumes

### WATER ADAPTOR

Enables water supply to be connected to the tool for water suppression during masonry cuts, with hose running inside housing

### Concrete Cutting Speed

**CE001G** **125**

Predecessor engine model **100**

slow speed fast



## MORE POWER MORE POSSIBILITIES

Οι μπαταρίες XGT<sup>®</sup> αποδίδουν έως και 40 V, δηλαδή διπλάσια από τις μπαταρίες 18 V της κορυφαίας στον κλάδο πλατφόρμας LXT. Αυτό σημαίνει ότι επιτρέπουν μια άνευ προηγουμένου ανεξαρτησία από σταθερές πηγές ενέργειας.

### Built Tough

Οι νέες μπαταρίες XGT<sup>®</sup> έχουν σχεδιαστεί ειδικά για να είναι εξαιρετικά ανθεκτικές. Διαθέτουν αδιάβροχη δομή τριών στρώσεων και τερματική δομή πρόληψης βραχυκυκλώματος. Λόγω της αντοχής τους στο νερό και τη σκόνη, οι μπαταρίες και τα εργαλεία μπορούν να χρησιμοποιηθούν σε δύσκολες συνθήκες.

Οι μπαταρίες είναι επίσης εξοπλισμένες με εξωτερικό περίβλημα βαρέως τύπου και θήκη κυψέλης για καλύτερη αντοχή στους κραδασμούς. Οι ανθεκτικές ράγες τους τα κρατούν με ασφάλεια στη θέση τους όταν χρησιμοποιείτε τα νέα προϊόντα υψηλής ισχύος.



**DA3010****CB419** **€299.00**

Γωνιακό τράπανο 10mm

Angle drill 10mm

Max in steel	10 mm
Max in wood	25 mm
Input wattage	450 w
No Load Speed	0 - 2400 rpm
Net Weight	1.6 kg

**HP0300****CB411** ΕΙΔΙΚΗ ΤΙΜΗ  
SPECIAL PRICE**€81.00**

Δραπανοκατσάβιδο 10mm

Combi Drill 10mm

Max in steel	10 mm
Max in wood	28 mm
Max in masonry	8 mm
Chuck Capacity	10 mm
Torque Settings	20 + Drill
Max Torque S/H	21 / 56 Nm
Input wattage	320 w
No Load Speed	0 - 1500 / 450 rpm
Blows per Minute	0 - 22,500 / 6,750 ipm
Net Weight	1.3 kg

**DP2011****CB070** **€116.00**

Περιστροφικό Τράπανο 6.5mm

Rotary Drill 6.5mm

Max in steel	6,5 mm
Max in wood	15 mm
Input wattage	370 w
No Load Speed	0-4200 rpm
Net Weight	1.0 kg

**HP1631K****CB085** **€121.50**

Κρουστικό τράπανο 13mm

Percussion drill 13mm

Max in steel	13 mm
Max in wood	30 mm
Max in masonry	16 mm
Input wattage	710 w
No Load Speed	0 - 3200 rpm
Blows per Minute	0 - 480000 bpm
Net Weight	2.0 kg

**HP2050****CB419** **€190.00**

Κρουστικό τράπανο 2 ταχυτήτων 13mm

2 SPEED Percussion drill 13mm

Max in steel	13 mm
Max in wood	40 mm
Max in masonry	20 mm
Input wattage	720 w
No Load Speed	0 - 2900 / 1200 rpm
Blows per Minute	0 - 58000 / 24000 bpm
Net Weight	2.5 kg

Διατίθεται και σε  
Also available in **DS4012****CB411** **€263.00**

Περιστροφικό Τράπανο 13mm

Rotary Drill 13mm

Max in steel	13 mm
Max in wood	36 mm
Chuck Capacity	2-13 mm
Input wattage	750 w
No Load Speed	0 - 600 rpm
Net Weight	2.8 kg

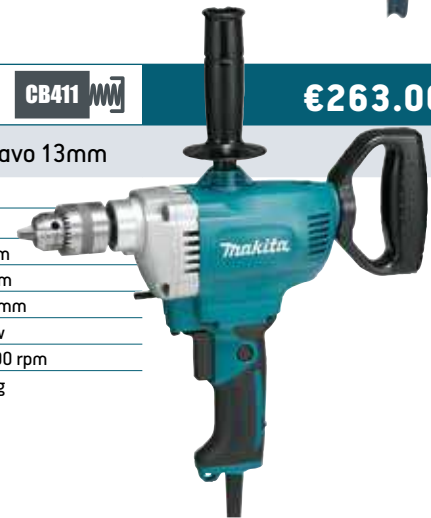
**DP4011****CB419** **€214.50**

Περιστροφικό Τράπανο 13mm

Rotary Drill 13mm

Max in steel	13 mm
Input wattage	720 w
No Load Speed	0 - 2900 / 1200 rpm
Net Weight	2.3 kg

**DP4700****CB064** **€288.00**

Περιστροφικό Τράπανο 13mm

Rotary Drill 13mm

Input wattage	510 w
No Load Speed	0 - 550 rpm
Net Weight	2.2 kg





# ΑΞΕΣΟΥΑΡ ΕΡΓΑΛΕΙΩΝ TOOL ACCESSORIES



# PLUS

Τα Makita SDS-Plus έχουν σχεδιαστεί με γνώμονα την αντοχή και τη δύναμη.

Αυτό το σετ εργαλείων θα σας επιτρέψει να σμιλεψετε στις περισσότερες επιφάνειες χωρίς αντίσταση. Με εργονομικό σχήμα για να μειώσετε τον κίνδυνο τραυματισμού όταν το χρησιμοποιείτε σε ημι-κανονική συχνότητα.

**HR2670**

**CB325** 

**€247.00**

SDS-Plus κρουστικό περιστροφικό 26mm

SDS-Plus rotary hammer 26mm

Opt. drilling capacity	4-18mm
Input wattage	800 w
No Load Speed	0 - 1500 rpm
Blows per Minute	0 - 4500 bpm
Net Weight	2.9 kg
Joules	EPTA: 2.4J, 3.0J

Συμπεριλαμβάνει πλαστική θήκη μεταφοράς  
Includes plastic carrying case



**HR2630**

**CB325** 

**€247.00**

SDS-Plus κρουστικό περιστροφικό 26mm

SDS-Plus rotary hammer 26mm

Opt. drilling capacity	15mm
Input wattage	800 w
No Load Speed	0 - 1200 rpm
Impacts per minute	0 - 4,600 ipm
Net Weight	2.8 kg
Joules	EPTA: 2.4J, 2.9J

Συμπεριλαμβάνει πλαστική θήκη μεταφοράς  
Includes plastic carrying case



**HR2630T**

**CB325** 

**€289.00**

SDS-Plus κρουστικό περιστροφικό 26mm

SDS-Plus rotary hammer 26mm

Opt. drilling capacity	15mm
Input wattage	800 w
No Load Speed	0 - 1200 rpm
Impacts per minute	0 - 4,600 ipm
Net Weight	2.8 kg
Joules	EPTA: 2.4J, 2.9J

Συμπεριλαμβάνει αυτόματο τσάκ γρήγορης αλλαγής και πλαστική θήκη πλαστική θήκη μεταφοράς  
Includes keyless chuck, adaptor and a plastic carrying case



**HR2810**

**CB325** 

**€410.00**

SDS-Plus κρουστικό περιστροφικό 28mm

SDS Plus Rotary Hammer 28mm

Max in concrete	28mm
Max in steel	13mm
Max in wood	32mm
Input wattage	800 w
No Load Speed	0 - 1100 rpm
Impacts per minute	0 - 4,500 ipm
Net Weight	3.4 - 3.8 kg
Joules	EPTA: 2.8J, 2.9J

Συμπεριλαμβάνει πλαστική θήκη μεταφοράς  
Includes plastic carrying case



HR2810

**HR3001C**

CB325 

**NEW**

**€475.00**

SDS-Plus κρουστικό περιστροφικό 30mm

SDS Plus Rotary Hammer 30mm

Max in concrete	30mm
Max in steel	13mm
Max in wood	32mm
Input wattage	1050 w
No Load Speed	0 - 840 rpm
Impacts per minute	0 - 4,500 ipm
Net Weight	4,4 kg
Joules	EPTA: 3.6J

Συμπεριλαμβάνει πλαστική θήκη μεταφοράς  
Includes plastic carrying case



**HR3012FC**

CB325 

**NEW**

**€540.50**

SDS-Plus κρουστικό περιστροφικό 30mm

SDS Plus Rotary Hammer 30mm

Max in concrete	30mm
Max in steel	13mm
Max in wood	32mm
Input wattage	1050 w
No Load Speed	0 - 840 rpm
Impacts per minute	0 - 4,500 ipm
Net Weight	4,8 kg
Joules	EPTA: 3.9J

Συμπεριλαμβάνει πλαστική θήκη μεταφοράς  
Includes plastic carrying case



# NEMESIS II

## Για SDS-Plus Κρουστικά Περιστροφικά

Το τρύπημα σε οπλισμένο σκυρόδεμα δεν αποτελεί πλέον χτύπημα και χάσιμο εφαρμογής, ούτε η οπλισμένη ράβδος αποτελεί πλέον εμπόδιο για το τρυπάνι Nemesis II. Επίσης είναι ιδανικό για χρήση σε σκληρότερη φυσική πέτρα. Η μοναδική συμμετρική γεωμετρία της κεφαλής του εξασφαλίζει οπές διάτρησης ακριβείας. Ιδανική για τις σημαντικές συνδέσεις αγκυρών και όπου απαιτείται τοποθέτηση σε σημεία. Το **Nemesis II** θα τρυπήσει έως και **50% περισσότερες τρύπες** από ένα κανονικό περιστροφικό τρυπάνι.



**HK1820**

CB325 

**€651.00**

SDS-Plus Σκαπτικό

SDS Plus Power Scraper

Input wattage	550 w
Impacts per minute	0 - 3,200 ipm
Net Weight	3.3 kg
Joules	EPTA: 3.1J

Συμπεριλαμβάνει πλαστική θήκη μεταφοράς  
Includes plastic carrying case



HK1820



# MAX

Τα κατεδαφιστικά/σκαπτικά Makita SDS Max είναι μηχανήματα μεγάλης ικανότητας που έχουν σχεδιαστεί ειδικά για εργασίες διάτρησης και κατεδάφισης.

Αυτά τα ισχυρά χειροκίνητα τρυπάνια σας παρέχουν γρήγορη και ασφαλή αφαίρεση υλικών για χρήση σε εργοτάξια. Αυτή η ισχυρή απόδοση συνδυάζεται με τον πιο πρόσφατο έλεγχο κραδασμών για να βοηθήσει στη μείωση της κόπωσης του χειριστή και στην αύξηση του ρυθμού εργασίας επί τόπου.

**HR4002**

**CB350** 

**€610.00**

SDS-Max κρουστικό περιστροφικό 40mm

SDS-Max Rotary Hammer 40mm

Opt. drilling capacity	22mm
Input wattage	1050 w
No Load Speed	0 - 680 rpm
Blows per Minute	0 - 2500 bpm
Net Weight	6.7 kg
Joules	6.1 J

Συμπεριλαμβάνει σμιθόρι  
Includes scaling chisel

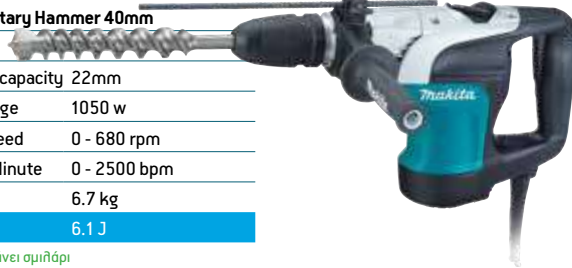

**HR4003C**

**CB350** 

**€695.50**

SDS-Max κρουστικό περιστροφικό 40mm

SDS-Max Rotary Hammer 40mm

Input wattage	1100 w
Max in concrete	40mm
Max core diameter	105mm
Opt. drilling capacity	22mm
No Load Speed	250-500rpm
Blows per Minute	1,450-2,900 ipm
Net Weight	6.3 kg
Joules	EPTA : 8.3J

Συμπεριλαμβάνει σμιθόρι  
Includes scaling chisel



New: Two on/off switches switchable in hammering mode



HR4013C / HR5212

## LOCK-ON IN HAMMER MODE



## SOFT NO LOAD

Automatically reduces the motor speed during idling to suppress the vibration of the machine body.



**HR4013C**

**CB350** 

**€829.00**

SDS-Max κρουστικό περιστροφικό σκαπτικό 40mm

SDS-Max AVT Rotary Hammer 40mm

Max in concrete	40 mm
Drilling Range	16 - 35 mm
Opt. drilling capacity	22mm
Input wattage	1000 w
No Load Speed	250 - 500 rpm
Impacts per minute	1450 - 2900 ipm
Net Weight	6.8 kg
Joules	EPTA: 8.0J, 11.4J

Συμπεριλαμβάνει σμιθόρι  
Includes scaling chisel



**HR5212C**

**CB175** 

**€1229.00**

SDS-Max κρουστικό περιστροφικό σκαπτικό 50mm

SDS-Max AVT Rotary Hammer 50mm

Max in concrete	52 mm
Max core diameter	160 mm
Drilling Range	25 - 45 mm
Opt. drilling capacity	28mm
Input wattage	1510 w
No Load Speed	150 - 310 rpm
Impacts per minute	1100 - 2250 ipm
Net Weight	11.9 kg
Joules	EPTA: 19.1J, 21.0J

Συμπεριλαμβάνει σμιθόρι  
Includes scaling chisel



**HM0870C** **CB350** **MM** **€593.00**

SDS-Max Σκαπτικό - Κατεδαφιστικό

SDS-Max Demolition Hammer

Input wattage	1100 w
Blows per Minute	1100-2650 bpm
Net Weight	5.1kg
Joules	EPTA: 7.6J, 11.4J

Συμπεριλαμβάνει σμιλήρι  
Includes scaling chisel

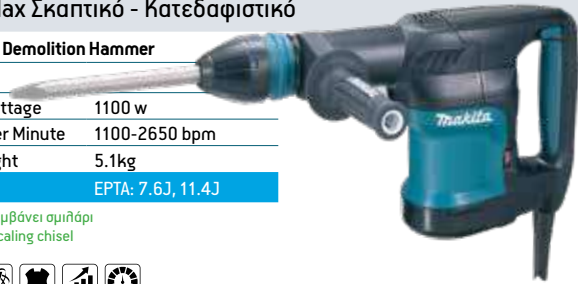

**HM0871C** **CB350** **MM** **€662.00**

SDS-Max Σκαπτικό - Κατεδαφιστικό

SDS-Max AVT Demolition Hammer

Input wattage	1100 w
Blows per Minute	1100-2650 bpm
Net Weight	5.7kg
Joules	EPTA: 8.1J, 11.6J

Συμπεριλαμβάνει σμιλήρι  
Includes scaling chisel



**HM1101C** **CB175** **MM** **€874.50**

SDS-Max Σκαπτικό - Κατεδαφιστικό

SDS-Max Demolition Hammer

Input wattage	1300 w
Blows per Minute	1100-2660 bpm
Net Weight	7.2 kg
Joules	EPTA: 11.5J, 17.2J

Συμπεριλαμβάνει σμιλήρι  
Includes scaling chisel



**HM1203C** **CB175** **MM** **€863.00**

SDS-Max Σκαπτικό - Κατεδαφιστικό

SDS-Max Demolition Hammer

Input wattage	1510 w
Blows per Minute	950 - 1900 bpm
Net Weight	9.7 kg
Joules	EPTA: 19.1 J, 25.5J

Συμπεριλαμβάνει σμιλήρι  
Includes scaling chisel



**HM1213C** **CB175** **MM** **€890.00**

SDS-Max Σκαπτικό - Κατεδαφιστικό

SDS-Max AVT Demolition Hammer

Input wattage	1500 w
Blows per Minute	950 - 1900 bpm
Net Weight	10.8 kg
Joules	EPTA: 18.6 J, 25.5J

Συμπεριλαμβάνει σμιλήρι  
Includes scaling chisel



Διατίθεται και σε  
Also available in **110v**



**HM1317C** **CB175** **MM** **€1352.00**

Σκαπτικό - Κατεδαφιστικό

AVT Demolition Hammer

Input wattage	1510 w
Blows per Minute	730-1450 bpm
Net Weight	17 kg
Joules	EPTA: 25.0J, 33.8J

Συμπεριλαμβάνει σμιλήρι  
Includes scaling chisel

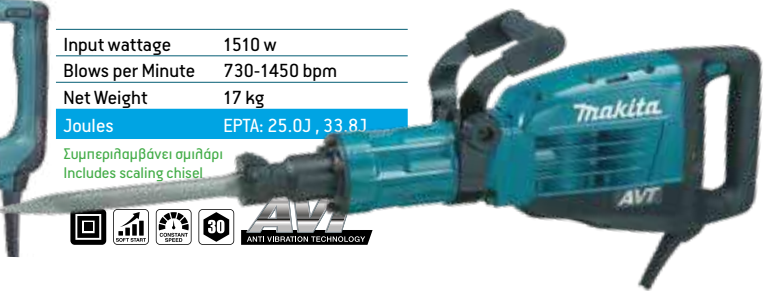

**HM1812** **CB175** **MM** **€2211.50**

Σκαπτικό - Κατεδαφιστικό

AVT Electric Breaker

Impact energy	72.8 J
Input wattage	2,000 w
Drive shank Hex	1 1/4" "
Blows per Minute	870 bpm
Net Weight	31.3 kg

Ultra-Low Vibration **6.5 m/sec<sup>2</sup> (EN60745)**

Συμπεριλαμβάνει σμιλήρι  
Includes scaling chisel



**AVT** **SOFT**  
ANTI VIBRATION TECHNOLOGY **NO LOAD**



Hammer Tool Care & Accessories

Find in **accessories** section



## EK8100WS

€1650.00

Κόφτης Δομικών Υλικών 81cc

Petrol Power Disc Cutter 81cc

Max. Cutting Depth	147 mm
Engine	2-Stroke
Arbor	25.4mm
Max spindle speed	3,820rpm
Wheel diameter	405mm
Power Rating	5.6 hp
Fuel Tank Capacity	1.1L
Fuel Type	Mixed Gasoline
Net Weight	10.6kg



EK8100



## UT2204

CB303

€297.00

Αναδευτήρας

Mixer

Shaft Diameter	12 mm
Max Paddle Diameter	220 mm
Tool holder size	M14
Rated Power Input	850 w
No Load Speed	550 rpm
Net Weight	2.7 kg

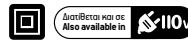

## UT1401

€454.50

Αναδευτήρας 140mm

Paddle Mixer 140mm

Mixing Capacity	50 kg
Max Paddle Diameter	140 mm
Tool holder size	M14 female
Rated Power Input	1300 w
No Load Speed	0-450 rpm
Net Weight	5.5 kg



## UT1600

€591.50

Αναδευτήρας 180mm

Paddle Mixer 180mm

Mixing Capacity	80 kg
Max Paddle Diameter	180 mm
Tool holder size	M14 female
Rated Power Input	1800 w
No Load Speed	0-580 rpm
Net Weight	7.1 kg



## UT2204 Mixer Accessories

Find in **accessories** section

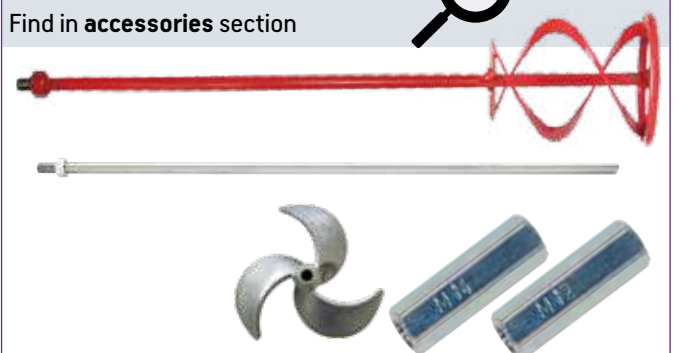

# Μειώνει τις δονήσεις του γωνιακού τροχού

## SJS II

### SUPER JOINT SYSTEM

Το αναβαθμισμένο SJS II έχει μειώσει δραματικά τη δόνηση των γωνιακών τροχών.

Το φυλλωτό ελατήριο απορροφά τους κραδασμούς και ανακουφίζει από την κρούση κατά τη λειτουργία έως και 12,5% σε σχέση με την αρχική SJS τεχνολογία.

Όταν χρησιμοποιείτε τη αντι-κραδασμική λαβή, μπορεί να ανακουφίσει τους κραδασμούς έως και 25% σε σχέση με το αρχικό SJS (Super Joint System).

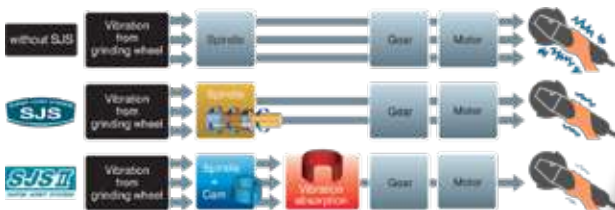
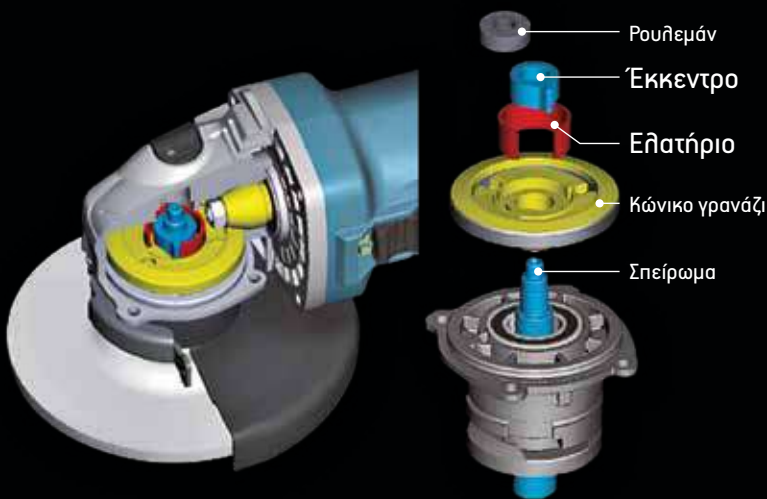

**GA4530R****CB459** **€105.00**

Σμυρίδιος 115mm (4½")

Angle grinder 115mm (4½")

Anti Restart Function	✓
Bore Diameter	22.23 mm
Max Wheel Diameter	115 mm
Input Wattage	720 w
No Load Speed	11,000 rpm
Net Weight	2.0 kg

**9557HNRG****CB325** **€114.00**

Σμυρίδιος 115mm (4½")

Angle grinder 115mm (4½")

Anti Restart Function	✓
Bore Diameter	22,23 mm
Max Wheel Diameter	115 mm
Input Wattage	840 w
No Load Speed	11,000 rpm
Net Weight	2.0 kg

Also available in **9564PCV****CB318** **€209.00**

Σμυρίδιος 115mm (4½")

Angle grinder 115mm (4½")

Variable speed control	✓
Bore Diameter	22 mm
Max Wheel Diameter	115 mm
Input Wattage	1400 w
No Load Speed	2800 - 12,000 rpm
Net Weight	2.5 kg

**SJS II**  
**SUPER JOINT SYSTEM***Leaf spring absorbs vibration and relieves shock during operation***GA4540R01****CB318** **€186.00**

Σμυρίδιος 115mm (4½")

Angle grinder 115mm (4½")

Anti Restart Function	✓
Bore Diameter	22.23 mm
Max Wheel Thickness	6 mm
Max Wheel Diameter	115 mm
Input Wattage	1,100 w
No Load Speed	11,000 rpm
Net Weight	2.6 kg



GA4540R01



**GA5030R**    **CB459**     **€109.00**

Σμυρίδιος 125mm (5")

Angle grinder 125mm (5")

Anti Restart Function	✓
Bore Diameter	22.23 mm
Max Wheel Diameter	125 mm
Input Wattage	720 w
No Load Speed	11000 rpm
Net Weight	2.0 kg



**9565CR**    **CB318**     **€176.00**

Σμυρίδιος 125mm (5")

Angle grinder 125mm (5")

Anti Restart Function	✓
Bore Diameter	22 mm
Max Wheel Diameter	125 mm
Input Wattage	1400 w
No Load Speed	12,000 rpm
Net Weight	2.2 kg



**GA5021**    **CB303**     **€195.00**

Σμυρίδιος 125mm (5")

Angle grinder 125mm (5")

Bore Diameter	22mm
Max Wheel Diameter	125 mm
Spindle Size	M14x2mm
Input Wattage	1050 w
No Load Speed	12000 rpm
Net Weight	3.3 kg



**GA9090N**    **CB203**     **€144.00**

Σμυρίδιος 230mm (9")

Angle grinder 230mm (9")

Bore Diameter	22,23mm
Max Wheel Diameter	230 mm
Spindle Size	M14
Input Wattage	2,200 w
No Load Speed	6600 rpm
Net Weight	5.3 kg

 Mainly targets METAL grinding operations.



**GA9020**    **CB203**     **€179.00**

Σμυρίδιος 230mm (9")

Angle grinder 230mm (9")

Bore Diameter	22mm
Max Wheel Diameter	230 mm
Spindle Size	M14x2mm
Input Wattage	2,000 w
No Load Speed	6600 rpm
Net Weight	5.9 kg



Διατίθεται και σε 110v 



**GA9040S**    **CB203**     **€239.50**

Σμυρίδιος 230mm (9")

Angle grinder 230mm (9")

Bore Diameter	22mm
Max Wheel Diameter	230 mm
Spindle Size	M14x2mm
Input Wattage	2,400 w
No Load Speed	6600 rpm
Net Weight	6.9 kg



Angle Grinder Accessories

Find in accessories section 



## HG6530VK

€175.00

Πιστόλι Θερμού Αέρος

Heat Gun

Temperature 50 - 650 °C

Input Wattage 2,000 w

Net Weight 0.670 kg



HG6531CK

*Προκαθορισμένη λειτουργία:  
Ανάλογα με την προβλεπόμενη χρήση,  
μπορείτε να ανακαλέσετε τις αποθηκευμένες  
ρυθμίσεις και να ρυθμίσετε εύκολα τη  
θερμοκρασία και τον όγκο ροής αέρα.  
Το όνομα κάθε ρύθμισης εμφανίζεται στην  
οθόνη LCD.*



## HG6531CK

€208.00

Πιστόλι Θερμού Αέρος

Heat Gun

Temperature 50 - 650 °C

Airflow 200 - 550 litres/min

Input Wattage 2,000 w

Net Weight 0.71 kg

14 διαθέσιμες ρυθμίσεις



# ΜΑΚ

# ΡΑC

## Ο ΕΞΥΓΝΟΣ ΤΡΟΠΟΣ ΑΠΟΘΗΚΕΥΣΗΣ ΕΡΓΑΛΕΙΩΝ ΚΑΙ ΑΞΕΣΟΥΑΡ

Το σύστημα σύνδεσης MakPac αποτελείται από τέσσερις διαφορετικές πλαστικές θήκες που ποικίλλουν σε ύψος, μία εργαλειοθήκη και 2 τρόλληι μεταφοράς.

Οι θήκες μπορούν να στοιβάζονται η μία επάνω στην άλλη και να κλειδώνονται μαζί με τα μάνδαλα ασφάλισης. Ένθετα για τα εργαλεία και τα αξεσουάρ σας είναι επίσης διαθέσιμα.

Οι διασυνδεδεμένες θήκες καταλαμβάνουν μικρότερο χώρο αποθήκευσης και είναι εύκολο να μεταφερθούν από και προς το χώρο εργασίας.

## SMART FEATURES



**GD0602****CB325** **€107.50**

Λειαντήρας ίσιος

Die Grinder 6mm

Collet Capacity	6 mm
Input wattage	400 w
No Load Speed	25000 rpm
Net Weight	1.4 kg

**GD0800C****CB318** **€386.50**

Λειαντήρας ίσιος

Die Grinder 8mm

Collet Capacity	8 mm
Input wattage	750 w
No Load Speed	7000 - 28000 rpm
Net Weight	1.88 kg

**GS5000****CB318** **€436.00**

Λειαντήρας ίσιος 125mm

Straight grinder 125mm

Bore Diameter	20 mm
Wheel diameter	125 mm
Input wattage	750 w
No Load Speed	5,600 rpm
Net Weight	5.0 - 5.2 kg



GS5000

**JS1601****CB459** **€428.00**

Κόφτης λαμαρίνας 1.6mm

Shear 1.6mm

Max. in steel	1.6 mm
Max in aluminium	2.5 mm
Strokes per Minute	4500 spm
Input Wattage	380 w
Net Weight	1.4 kg

**JS1602J****CB459** **€413.00**

Κόφτης λαμαρίνας 1.6mm

Metal Shear 1.6mm

Max. in steel	1.6 mm
Max in aluminium	2.5 mm
Strokes per Minute	4000 spm
Input Wattage	380 w
Net Weight	1.6 kg

**JS3201J****CB303** **€514.00**

Κόφτης λαμαρίνας 3.2mm

Shear 3.2mm

Max. in mild steel	3.2 mm
Max cut in stainless steel	2.5 mm
Max in aluminium	4.0 mm
Min Cutting Radius	50 mm
No Load Speed	1,600 rpm
Input Wattage	710 w
Net Weight	3.4 kg

Συμπεριλαμβάνει πλαστική θήκη μεταφοράς  
Includes plastic carrying case

JS3201J

**JN1601**      **CB411**       **€482.00**

Κόφτης λαμαρίνας 1.6mm

Nibbler 1.6mm

Max. in steel	1.6 mm
Max cut in stainless steel	1.2 mm
Min Cutting Outside Edge	50 mm
Radius Inside Edge	45 mm
Strokes per Minute	2200 spm
Input Wattage	550 w
Net Weight	1.6 kg



**JN3201J**      **CB303**       **ΕΙΔΙΚΗ ΤΙΜΗ SPECIAL PRICE €665.00**

Κόφτης λαμαρίνας 3.2mm

Nibbler 3.2mm

Max. in steel	3.2 mm
Max cut in stainless steel	2.5 mm
Max in aluminium	3.5 mm
No Load Speed	1,300 rpm
Input Wattage	710 w
Net Weight	3.4 kg



**CA5000XJ**      **CB303**       **€665.00**

Χαράκτης αλουμινίου 165mm

Aluminium groove cutter 165mm

Cutter blade diameter	118 mm
TCT Blade Diameter	165 mm
Bore Diameter	20 mm
No Load Speed	2,600 - 6,400 rpm
Input Wattage	1,300 w
Net Weight	4.7 kg



Συμπεριλαμβάνει δίσκο κοπής  
Includes cutting disk

- Can be used as a plunge saw by removing skirt and replacing cutter blade with 165mm Saw Blade
- 118mm 6-tooth Cutter blade for 90° V-shaped groove supplied as standard



CA5000XJ



**Guide Rails**

Find in **accessories** section

**LW1401S**      **CB203**       **€306.00**

Φορητός κόφτης μετάλλων 355mm

Portable cut off 355mm (14")

Hole Diameter	25.4 mm
Max Wheel Thickness	3 mm
Max Wheel Diameter	355 mm
Input Wattage	2200 w
No Load Speed	3,800 rpm
Net Weight	18.3 kg



Συμπεριλαμβάνει δίσκο κοπής  
Includes cutting disk



**LC1230N**      **CB203**       **€591.00**

Φορητός κόφτης μετάλλων 305mm - Ψυχράς κοπής

Portable TCT cut off 305mm (12") - Cold Cuts

Hole Diameter	25.4 mm
Max Wheel Diameter	305 mm
Depth of Cut @ 90°	115 mm
Depth of Cut @ 45°	90 mm
Input Wattage	1650 w
No Load Speed	1300 rpm
Net Weight	19.3 kg



Συμπεριλαμβάνει δίσκο κοπής  
Includes cutting disk



LC1230N

**FS4300**CB419 **€199.00**

Κατσαβίδι γυψοσανίδας 1/4"

Drywall screwdriver 1/4"

Capacity Drywall Screw	5 mm
Capacity Self Drilling Screw	6 mm
Drive shank Hex	1/4 "
Torque Settings; S/H	10/16 Nm
No Load Speed	0 - 4000 rpm
Net Weight	1.4 kg



FS4300

**TD0101F**CB411 **€140.00**

Παθητικό κατσαβίδι 1/4"

Impact driver drill 1/4"

Drive shank Hex	1/4 "
High Tensile Bolt	M5-M10
Impacts	0 - 3000 ipm
Input wattage	200 w
Max Torque	90 Nm
No Load Speed	0 - 3500 rpm
Net Weight	0.99 kg



TD0101F



- Ergonomically designed handle with rubberized soft grip
- Push button for reversing
- Variable speed control by trigger
- Externally accessible carbon brush
- Phosphorescent bumper (convenient in dark places)

TW0350

CB411 **€380.00**

Παθητικό ηλεκτρόκλειδο 1/2"

Impact wrench 1/2"

Max Socket Size	32 mm A/F
Bolt Range	M12-M22
Drive Square	1/2 "
Input wattage	400 w
Max Torque	350 Nm
Impacts	2,000 ipm
No Load Speed	2000 rpm
Net Weight	3.0 kg



SEE PAGE 124

**NEW**  
NEO

UH6580

**Makita**<sup>®</sup>

**OUTDOOR  
POWER**

**4329****CB064** **€110.00**

Πριόνι

Orbital Action Jig Saw

Max in steel	6 mm
Max in wood	65 mm
Strokes per Minute	500-3100 spm
Stroke Length	18 mm
Input wattage	450 w
Net Weight	1.9 kg

**4350CT****CB064** **€263.00**

Πριόνι

Orbital Action Jig Saw

Max in steel	10 mm
Max in wood	135 mm
Strokes per Minute	800-2800 spm
Stroke Length	26 mm
Input wattage	720 w
Net Weight	2.7 kg



Also available in  110v

**JR3051TK****CB303** **€206.00**

Πριόνι

Recipro Saw

Max cut in pipe	130 mm
Max in wood	255 mm
Strokes per Minute	0 – 3,000 spm
Stroke Length	30 mm
Input wattage	1200 w
Net Weight	3.2 kg



Συμπεριλαμβάνει πλαστική θήκη μεταφοράς  
Includes plastic carrying case

**JR3070CT****CB303** **€370.00**

Πριόνι

Recipro Saw

Max cut in pipe	130 mm
Max in wood	255 mm
Strokes per Minute	0-2800 spm
Stroke Length	32 mm
Input wattage	1510 w
Net Weight	4.6 kg



Συμπεριλαμβάνει πλαστική θήκη μεταφοράς  
Includes plastic carrying case



# AVT™

ANTI VIBRATION TECHNOLOGY

Breakthrough technology enables high power to be coupled with an

# EXCEPTIONALLY LOW VIBRATION

**HS6601**

CB303 

**€173.00**

Δισκοπρίνο 165mm

Circular Saw 165mm

Depth of Cut @ 90°	54.5 mm
Depth of Cut @ 45°	37.5 mm
Blade Diameter	165 mm
Bore Diameter	20 mm
No Load Speed	5200 rpm
Input wattage	1050 w
Net Weight	3.4 kg

Συμπεριλαμβάνει δίσκο κοπής  
Includes cutting disk



**LB1200F**

ΕΙΔΙΚΗ ΤΙΜΗ  
SPECIAL PRICE

**€1169.00**

Πριόνι Κορδέλα 165mm

Band Saw 165mm

Cutting Capacity	165 - 305 mm
Blade Diameter	2240 mm
Blade Thickness Range	6 - 16 mm
Cutting speed	6.7 - 13.3 m/sec
Table height	100 cm
Table tilt	-2 - +45°
Table size	560 x 400 mm
Input wattage	900 w
Net Weight	82 kg

Συμπεριλαμβάνει πριονοκορδέλα κοπής  
Includes cutting band



**HS7601J**

CB303 

**€232.00**

Δισκοπρίνο 190mm

Circular Saw 190mm

Depth of Cut @ 90°	66 mm
Depth of Cut @ 45°	46 mm
Blade Diameter	190 mm
Bore Diameter	30 mm
No Load Speed	5200 rpm
Input wattage	1200 w
Net Weight	3.8 kg

Συμπεριλαμβάνει δίσκο κοπής  
Includes cutting disk



**5903RK**

CB203 

**€485.00**

Δισκοπρίνο 235mm

Circular Saw 235mm

Depth of Cut @ 90°	85 mm
Depth of Cut @ 45°	64 mm
Blade Diameter	235 mm
Bore Diameter	30 mm
No Load Speed	4500 rpm
Input wattage	1550 w
Net Weight	7.2 kg

Συμπεριλαμβάνει δίσκο κοπής και πλαστική  
θήκη μεταφοράς  
Includes cutting disk and plastic carrying case



**5143R**

CB203 

**€1151.00**

Δισκοπρίνο 355mm

Circular Saw 355mm

Depth of Cut @ 90°	130 mm
Depth of Cut @ 45°	90 mm
Blade Diameter	355 mm
Bore Diameter	30 mm
No Load Speed	2700 rpm
Input wattage	2200 w
Net Weight	12.5 kg

Συμπεριλαμβάνει δίσκο κοπής  
Includes cutting disk



**MLS100N****CB153** **€328.00**

Δισκοπρίοο Πάγκου 255mm

Mitre Saw 255mm

Blade Diameter	255 mm	Capacity 45° (left)	48 x 120 mm
Input wattage	1500 w	Capacity 45°	75 x 90 mm
Max bevel range	45 - 0°	Capacity 90°	75 x 130 mm
No Load Speed	4200 rpm	Max mitre range	45°
Net Weight	14.7 kg		

Συμπεριλαμβάνει δίσκο κοπής  
Includes cutting disk**LH1040****CB153** **€635.00**

Σύνθετο δισκοπρίοοο πάγκου διπλό 260mm

Table top miter Saw 260mm

Blade Diameter	260 mm	Max mitre cut at 45°	69 x 85 mm
Bore Diameter	25 mm	Max mitre cut at 90°	69 x 130 mm
Input wattage	1650 w	Max mitre range	45 - 52°
Max bevel range	45 - 0°	No Load Speed	4800 rpm
Max table cut	40 mm	Net Weight	14.3 kg

Συμπεριλαμβάνει δίσκο κοπής  
Includes cutting disk**LH1201FL****CB153** ΕΙΔΙΚΗ ΤΙΜΗ  
SPECIAL PRICE**€874.50**

Σύνθετο δισκοπρίοοο πάγκου διπλό 305mm

Table top miter Saw 305mm

Blade Diameter	305 mm	Max mitre range	47 - 52°
Bore Diameter	30 mm	Table Saw Capacity	52 mm
Input wattage	1650 w	No Load Speed	3,800 rpm
Max bevel range	45 - 0°	Net Weight	20.9 kg

Συμπεριλαμβάνει δίσκο κοπής  
Includes cutting disk**2712****€819.00**

Δισκοπρίοοο πάγκου 315mm

Table Saw 315mm

Blade Diameter	315 mm	Bevel Angle Settings	0 - 45°
Bore Diameter	30 mm	Main table	550 x 800 mm
Input wattage	2000 w	Rear Extension	400 x 800 mm
Depth of Cut @ 90°	85 mm	No Load Speed	2,950 rpm
Depth of Cut @ 45°	58 mm	Net Weight	54 kg

Συμπεριλαμβάνει δίσκο κοπής  
Includes cutting disk

- Equipped with a robust, maintenance-free induction motor
- Precise adjustment of blade angle and height
- Rear extension for large work surface
- Equipped with 2 foldable handles and wheels for easy movement
- Rip fence (Guide rule)
- Removable edge ruler: allows cutting thin and wide materials
- Connectable to a vacuum cleaner



**Miter saw**

**Makita's First Flip Over Saw LF1000**

**Flipper**

**Table saw**

Light Weight Motor  
Quick & Easy Conversion

Compact Fold-Away Legs  
Light Weight 32kg (total incl. legs)

**Rigid Cast Aluminium Table**

- Tough Motor**  
Ideal for:  
1) Cutting Material with load  
2) Bevel Cut (Max. 45° left)  
3) Cutting Thick Material
- Removable Sub Fence**  
enables to cut thin and wide materials
- Soft Start**  
prevents breaker from tripping at job sites
- Electric Brake**  
for your safety
- On-Off Switch with Anti-Restart Function**  
protects operator from accidental start. Also equipped with Lock-On and Lock-Off function.
- Constant Speed**  
maintains constant cutting speed under operational load.

**LF1000**

**CB153**

**€1377.00**

Δισκοπρίνο με πόδια διπλά 260mm

Flip over Saw 260mm

Blade Diameter	260 mm	Max mitre cut at 45°	50 x 140 mm
Bore Diameter	30 mm	Max mitre cut at 90°	68 x 155 mm
Input wattage	1650 w	Max mitre range	45 - 45°
Max bevel range	45 - 0°	No Load Speed	2700 rpm
Max table cut	70 mm	Net Weight	36 kg

Συμπεριλαμβάνει δίσκο κοπής  
Includes cutting disk



**LS1110F****€563.00**

Δισκοπρίνο πάγκου 260mm με laser

Slide Compound Mitre Saw 260mm with laser

Blade Diameter	260 mm	Max mitre range	47 - 47°
Bore Diameter	30 mm	Max mitre range 90°	91 x 310 mm
Input wattage	1450 w	No Load Speed	4500 rpm
Max bevel range	47 - 2°	Net Weight	21.6 kg

Συμπεριλαμβάνει δίσκο κοπής  
Includes cutting disk**LS1018LN****CB153****€899.00**

Δισκοπρίνο πάγκου 260mm

Slide Compound Mitre Saw 255mm

Blade Diameter	260 mm	Max mitre range 45°	91 x 220 mm
Bore Diameter	30 mm	Max mitre range 90°	91 x 310 mm
Input wattage	1430 w	No Load Speed	4300 rpm
Max bevel range	45 - 45°	Net Weight	20.6 kg

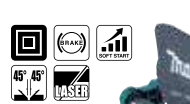
Συμπεριλαμβάνει δίσκο κοπής  
Includes cutting disk**LS1019L****CB155****€1219.00**

Δισκοπρίνο πάγκου 260mm με laser

Slide Compound Mitre Saw 260mm with laser

Blade Diameter	260 mm	Max mitre range	60 - 60°
Bore Diameter	30 mm	Max mitre range 90°	68 x 310 mm
Input wattage	1510 w	No Load Speed	3200 rpm
Max bevel range	48 - 48°	Net Weight	26.3 kg

Συμπεριλαμβάνει δίσκο κοπής  
Includes cutting disk**LS1219L****CB155****€1421.00**

Δισκοπρίνο πάγκου 305mm με laser

Slide Compound Mitre Saw 305mm with laser

Blade Diameter	305 mm	Max mitre range	60 - 60°
Bore Diameter	30 mm	Max mitre range 90°	92 x 382 mm
Input wattage	1,800 w	No Load Speed	3200 rpm
Max bevel range	48 - 48°	Net Weight	29.5 kg

Συμπεριλαμβάνει δίσκο κοπής  
Includes cutting disk**Universal Saw Stands**

Find in accessories section



# Makita®

# ΖΩΝΕΣ, ΤΣΑΝΤΕΣ & ΘΗΚΕΣ ΤΡΙΤΗΣ ΓΕΝΙΑΣ

## THIRD GENERATION BELTS POUCHES, BAGS & HOLDERS

STRAP/BELT  
SYSTEM

REAL  
LEATHER

HEAVY-LOAD  
SUPPORT SYSTEM

DURABLE  
RIVETING

TOOL  
LOOPS  
SYSTEM

LOOP-CLIP  
SOLUTION

CS  
BACKPACK  
CARRYING  
SYSTEM

BELT LOOP  
HOLDER

WATERPROOF  
BOTTOM

RAIL GUIDE  
SYSTEM

ANTI SLIP

ELASTIC  
LOOPS

3 LAYERS

SIDE-GATE  
SOLUTION

Makita are delighted to have launched a new and improved collection of belts and pouches to our extensive and popular range of accessories.

The newly designed range makes it even easier for tradespeople to safely and easily store and transport their tools and accessories. The collection includes belts, braces, pouches, holders, bags, cases, gear and equipment, and offers users the durability and reliability needed for everyday use.

Μια νέα και βελτιωμένη συλλογή από ζώνες και θήκες στην εκτεταμένη και δημοφιλή γκάμα Makita αξεσουάρ.

Η νέα σχεδιασμένη σειρά διευκολύνει τους εμπόρους να αποθηκεύουν και να μεταφέρουν με ασφάλεια και ευκολία τα εργαλεία και τα αξεσουάρ τους.

Η συλλογή περιλαμβάνει ζώνες, τιράντες, θήκες, τσάντες και προσφέρει στους χρήστες την ανθεκτικότητα και την αξιοπιστία που χρειάζονται για καθημερινή χρήση.



**9911****CB411** **€196.00**

Τριβείο ταινίας 3" (76x457mm)

Belt sander 3" (76x457mm)

Belt Size 76 x 457 mm

Belt Speed 75 - 270 m/min

Input wattage 650 w

Net Weight 2.7 kg

**9404****CB303** **€432.00**

Τριβείο ταινίας 4" (100 x 610mm)

Belt sander 100mm(4") x 610mm

Belt Size 100 x 610 mm

Belt Speed 210 - 440 m/min

Input wattage 1010 w

Net Weight 4.8 kg

**B03710****CB064** **€95.00**

Παθητικό τριβείο 92 x 185mm

Finishing sander 92 x 185mm

Strokes per Minute 22000 spm

Orbits per Minute 11000 opm

Pad Size 92 x 185 mm

Paper Size 93 x 228 mm

Net Weight 1.6 kg



B03710

**B04556****CB419** **€95.00**

Παθητικό τριβείο 112 x 102mm

Finishing sander 112 x 102mm

Abrasive Sheet 114 x 140 mm

Input wattage 200 w

Orbits per Minute 14000 opm

Orbit Diameter 1.5 mm

Pad Size 112 x 102 mm

Net Weight 1.1 kg

**B04900****CB419** **€307.00**

Παθητικό τριβείο 115 x 229mm

Finishing sander 115 x 229mm

Abrasive Sheet 115 x 280 mm

Input wattage 330 w

Orbits per Minute 10000 opm

Orbit Diameter 2.6 mm

Pad Size 115 x 229 mm

Net Weight 2.9 kg



B04556

**9046****CB419** **€353.50**

Παθητικό τριβείο 115 x 229mm

Finishing sander 115 x 229mm

Abrasive Sheet 115 x 280 mm

Input wattage 600 w

Orbits per Minute 6000 opm

Orbit Diameter 5 mm

Pad Size 115 x 229 mm

Net Weight 3.1 kg



**B05030**    **CB419**     **€154.00**

Κυκλοπαθημικό τριβείο 125mm

Random orbit sander 125mm

Abrasive Sheet	125 mm
Pad Size	123 mm
Input wattage	300 w
Orbits per Minute	12000 opm
Net Weight	1.3 kg



**B05041**    **CB419**     **€198.00**

Κυκλοπαθημικό τριβείο 125mm

Random orbit sander 125mm

Variable speed control	✓
Abrasive Sheet	125 mm
Pad Size	123 mm
Input wattage	300 w
Orbits per Minute	4.000 - 12.000 opm
Net Weight	1.4 kg

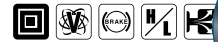

Rotatable Front Grip Provides More Control & Comfort

**B06050J**    **CB325**     **€531.50**

Κυκλοπαθημικό τριβείο 150mm

Random orbit sander 150mm

Variable speed control	✓
Abrasive Sheet	150 mm
Pad Size	150 mm
Input wattage	750 w
Orbits per Minute	1,600 - 6,800
Net Weight	2.6 kg



**9237CB**    **CB303**     **ΕΙΔΙΚΗ ΤΙΜΗ SPECIAL PRICE €384.00**

Στιλβωτήρας (πολισiera) 180mm

Polisher 180mm

Variable speed control	✓
Wool Bonnet Diameter	180 mm
Input wattage	1,200 w
No Load Speed	600 - 3,200 rpm
Net Weight	3.4 kg



**SA7000C**    **CB203**     **€285.00**

Λειαντήρας 180mm (7")

Angle Sander 180mm (7")

Variable speed control	✓
Pad Size	180 mm
Input wattage	1600 w
No Load Speed	0 - 4000 rpm
Net Weight	3.5 kg



**P06000C**    **CB318**     **€480.00**

Κυκλοπαθημικό τριβείο 150mm

Random orbit sander 150mm

Variable speed control	✓
Orbit Diameter	5.5 mm
Pad Size	150 mm
Input wattage	900 w
Orbits per Minute	0 - 6800 opm
Net Weight	2.9 kg



**2 MODES:**

- scratch polishing
- final polishing/wax coating



KP0800XK

**KP0800XK**

CB411

**€243.50**

Πλάνν 82mm

Planner 82mm

Planing width	82mm
Planing depth	2.5mm
No load speed	17000 rpm
Input wattage	620 w
Net Weight	2.6 kg



**RT0702CX4** CB411

**€240.00**

Ρούτερ παλάμης 1/4" & 3/8"

Router - Trimmer 1/4" & 3/8"

Collet Capacity	6mm and 8mm
Capacity (Trimmer)	0 - 40 mm
Capacity (Plunge)	0 - 35 mm
No load speed	10000 - 34000 rpm
Input wattage	710 w
Net Weight	1.8 - 2.8 kg



**3711** CB411

**€122.00**

Ρούτερ παλάμης 1/4"

Trimmer 1/4"

Collet Capacity	6mm
No load speed	32000 rpm
Input wattage	530 w
Net Weight	1.5 kg



**3712** CB411

**€160.00**

Ρούτερ Παλάμης - Περιθωρίων 1/4"

Edge Milling Trimmer 1/4"

Collet Capacity	6mm
No load speed	32000 rpm
Input wattage	530 w
Net Weight	1.7 kg



**DUST EXTRACTION**

Ανάλογα με τον τύπο σκόνης στον οποίο εκτίθεστε, τη συγκέντρωση και το χρόνο έκθεσης, η εισπνοή σκόνης μπορεί να οδηγήσει σε σοβαρές μακροχρόνιες και απειλητικές ασθένειες.

Η Makita παρέχει αποτελεσματικές λύσεις, που καλύπτουν τις απαιτήσεις σας και βελτιώνουν την παραγωγικότητά σας.



**RP0900J** CB106  **€239.00**

Ρούτερ 1/4" - 3/8"

Plunge Router 1/4" - 3/8"

Collet Capacity	1/4 or 3/8"
Capacity (Plunge)	35 mm
No load speed	27000 rpm
Input wattage	900 w
Net Weight	2.7 kg



Συμπεριλαμβάνεται μακρὰς θήκη  
Includes makpac case



**RP1803X08** CB203  **€619.00**

Ρούτερ 1/2"

Plunge Router 1/2"

Collet Capacity	12mm (1/2")
Capacity (Plunge)	70 mm
No load speed	0 - 22,000 rpm
Input wattage	1,650 w
Net Weight	6.2 kg



**RP2303FC02** CB203  **€598.00**

Ρούτερ 1/2"

Plunge Router 1/2"

Collet Capacity	12mm (1/2")
Capacity (Plunge)	70 mm
No load speed	9000 - 23000 rpm
Input wattage	2100 w
Net Weight	6.21 kg



- New Fence - Fine Micro Adjustment
- Ergonomically contoured knob style handles fit operator's hands perfectly
- Lock-on facility for inverted routing
- Linear ball bearing for super-smooth plunge action
- Vacuum cleaner connection



**PJ7000** CB459  **€382.00**

Φρεζογκαβιθιέρα (μπισκοτιέρα)

Biscuit Jointer

Blade Diameter	100 mm
Blade Thickness	4 mm
Hole Diameter	22 mm
Input Wattage	700 w
No Load Speed	11000 rpm
Net Weight	2.8 kg

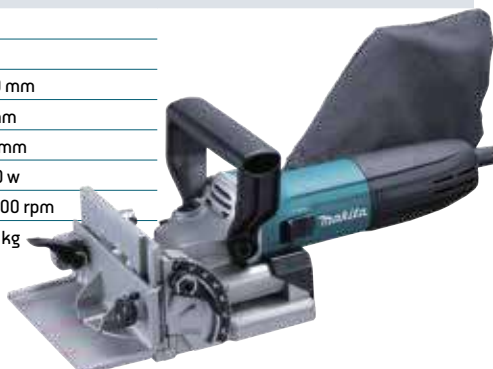

**TM3010CK****CB459****€226.00**

Πολυεργαλείο (εργαλείο μόνο)

Multitool (only tool)

Oscillation Angle	3.2°
Oscillations per Minute	6000 - 20000
Input wattage	320 w
Net Weight	1.6 kg

**UB1103****CB303****€125.00**

Φυστήρας

Blower

Max air volume	4.1 m <sup>3</sup> /min
Max Sealed Suction	5.7 kPa
Input wattage	600 w
No Load Speed	0 - 16000 rpm
Net Weight	1.9 kg

The blower can also be used as a vacuum



Blower » Vacuum Accessories

Find in accessories section

**FAST CLEAN UP**Αποτελεσματικό  
EfficiencyΜέγιστη ταχύτητα  
SpeedΑποδοτικό  
PerformanceΕύχρηστο  
Convenience

Maximum air volume of 145 cfm for faster clean up in larger areas

**203 MPH**

Delivers a maximum air speed of 203 MPH for faster job site clean up



Variable speed control dial and trigger (0-16,000 RPM) for increased performance



Two tools in one; quickly converts to a vacuum for added versatility

## PF0300

€109.00

Βυθιζόμενη αντλία 140L

Submersible Drainage Pump 140L

Pump Type	Clean Water
Max delivery volume	140 litres/min
Max Head	7 m
Max Submersion Depth	5 m
Max Solids Diameter	5 mm
Input wattage	300 w
Net Weight	4.23 kg



## PF0410

€116.00

Βυθιζόμενη αντλία 140L

Submersible Drainage Pump 140L

Pump Type	Dirty Water
Max delivery volume	140 litres/min
Max Head	5 m
Max Submersion Depth	5 m
Max Solids Diameter	35 mm
Input wattage	400 w
Net Weight	4.27 kg



## PF1100

€197.00

Βυθιζόμενη αντλία 250L

Submersible Drainage Pump 250L

Pump Type	Clean Water
Max delivery volume	250 litres/min
Max Head	9 m
Max Submersion Depth	5 m
Max Solids Diameter	5 mm
Input wattage	1,100 w
Net Weight	6.74 kg



## PF1110

€208.00

Βυθιζόμενη αντλία 250L

Submersible Drainage Pump 250L

Pump Type	Dirty Water
Max delivery volume	250 litres/min
Max Head	10 m
Max Submersion Depth	5 m
Max Solids Diameter	35 mm
Input wattage	1,100 w
Net Weight	7.00 kg



### Προτεινόμενες χρήσεις Recommended Uses



Irrigation and liquid transfer



Drainage of water tanks



Drainage in wells



## HW1300

€484.50

Πίεστικό Πίεσης 130 Bar

Pressure Washer 130 Bar

Regular pressure (Hi/Lo)	110 / 80 bar
Max Pressure	130 bar
Max Flow	450 l/hr
Hose length	10 m
Input power	1.8 kW
Net Weight	12.7 kg



HW1300



# Makita<sup>®</sup>

## mt



## NEW LINE UP

Όλες οι τιμές συμπεριλαμβάνουν 19% Φ.Π.Α - All prices are fully inclusive of 19% VAT

# Makita<sup>®</sup>

mt

## MT προέρχεται από το » Makita Technology «

Η σειρά MT της Makita προσφέρει μια σειρά εργαλείων σε προσιτή τιμή της αγοράς.

Η σειρά MT συνδυάζεται με την ποιότητα κατασκευής της βιομηχανίας με τις θεμελιώδεις επαγγελματικές απαιτήσεις, χωρίς την επαγγελματική τιμή.

Η σειρά MT είναι προσαρμοσμένη ώστε να ταιριάζει σε όλους τους απαιτητικούς οικιακούς χρήστες, οι οποίοι δεν απαιτούν όλα τα χαρακτηριστικά μιας επαγγελματικής μηχανής υψηλών προδιαγραφών, απλά ένα ισχυρό και αξιόπιστο εργαλείο για να κάνει τη δουλειά.



M6600B

**M6600B**

CB303

**€126.00**

Αναδευτήρας

Αναδευτήρας

Collet size	M12/M14
Input wattage	800W
No Load Speed	0-700rpm
Net Weight	3.4kg



**M9800BKX2**

CB459

**€191.00**

Πολυεργαλείο

Multi-Tool

Input wattage	200W
Oscillation per Minute	15,000 - 22,000rpm
Net Weight	1.2kg

Συμπεριλαμβάνει σετ με αξεσουάρ & θήκη  
Includes accessories kit & case

- 12 angle settings of accessories at every 30° from 0° to 360° allows for a wide range of applications
- Used for surface grinding and sawing of materials such as wood, plastic, metal, gypsum



**M8100B**

CB085

**€95.50**

Κρουστικό τράπανο 16mm

Hammer drill 16mm

Max. in concrete	16mm
Max. in steel	13mm
Max. in wood	30mm
Input wattage	710W
No Load Speed	0 - 3,200rpm
Net Weight	2.1kg



**M8600B**

CB105

**€278.00**

Σκαπτικό - κατεδαφιστικό 17mm hex shank

Demolition hammer 17mm Hex Shank

Impact energy	7.2j
Input wattage	900W
Impact Rate	2,900ipm
Net Weight	5.4kg

Συμπεριλαμβάνει σμιτάρι  
Includes chasing chisel



**M8103B**

CB085

**€75.50**

Κρουστικό τράπανο 13mm

Hammer drill 13mm

Max. in concrete	13mm
Max. in steel	13mm
Max. in wood	18mm
Input wattage	430W
No Load Speed	0 - 3,000rpm
Net Weight	1.8kg



**M8701B**CB325 **€160.00**

Κρουστικό τράπανο 26mm (3 mode)

Rotary hammer 26mm (3 mode)

Max. in concrete	16mm
Max. in steel	13mm
Max. in wood	32mm
Input wattage	800W
No Load Speed	0-1,200rpm
Net Weight	2.7kg
Joules	2.3 J

3 operation modes:

- hammering
- hammering with rotation
- rotation



M8701B

**M3600B**CB203 **€200.00**

Ρούτερ 12mm (1/2")

Router 12mm (1/2")

Base diameter	160x148mm
Plunge capacity	0-60mm
Collet capacity	12.7mm (1/2")
Input wattage	1,650W
No Load Speed	22,000rpm
Net Weight	5.5kg

**M3601B**CB106 **€126.00**

Ρούτερ 6 - 8mm (1/4 - 3/8")

Router 6 - 8mm (1/4 - 3/8")

Plunge capacity	0-35mm
Collet capacity	1/4 or 3/8"
Input wattage	900W
No Load Speed	27,000rpm
Net Weight	2.7kg

**M4301B**CB064 **€76.50**

Πριόνι 65mm

Jig saw 65mm

Strokes per Minute	0 - 3,100 spm
Length of Stroke	18mm
Input wattage	450W
Max. in steel	6mm
Max. in wood	65mm
Net Weight	1.9kg

**M5802B**CB303 **€169.00**

Δισκοπρίνο 190mm

Circular saw 190mm

Bevel Capacity	0° - 45°
Blade Diameter	190mm
Bore Diameter	30mm
Input wattage	1,050W
Max. at 0°	68mm
Max. at 45°	46mm
No Load Speed	4,900rpm
Net Weight	4.0kg

**M2401B**ΕΙΔΙΚΗ ΤΙΜΗ  
SPECIAL PRICECB203 **€199.00**

Κόφτης μετάλλων 355mm

Portable cut-off 355mm

Hole Diameter	25.4mm
Wheel diameter	355mm (14")
Input wattage	2,000W
No Load Speed	3,900rpm
Net Weight	15.3kg



M2401B



**M4501B** CB303  **€129.00**

Πριόνι 250mm

Recipro saw (καρχαρίας) 250mm

Length of Stroke	28mm
Input wattage	1,010W
Max. in pipe	130mm
Max. in wood	255mm
Strokes per minute	0 - 2,800spm
Net Weight	3.2kg



M3702B



**M9204B** CB419  **€96.00**

Κυκλοπαθημικό τριβείο 123mm

Random orbit sander 123mm

Paper diameter	125mm
Pad diameter	123mm
Input wattage	240W
Orbit diameter	2.8mm
Orbits per Minute	12,000opm
Net Weight	1.2kg



**M3702B** CB411  **€97.50**

Ρούτερ παλάμης 6mm

Trimmer 6mm

Plunge capacity	0-42mm
Collet capacity	6.35mm(1/4")
Input wattage	530W
No Load Speed	35,000rpm
Net Weight	1.4kg



**M9400B** CB153  **€260.00**

Τριβείο ταινίας 100mm (4") x 610mm

Belt sander 100mm (4") x 610mm

Belt Size	100 x 610mm
Belt Speed	380m/min
Input wattage	940W
Net Weight	6.2kg



**M4000B** CB085  **€62.00**

Φυσητήρας

Blower

Max air volume	1.2-2.9m <sup>3</sup> /min
Input wattage	530W
No Load Speed	8,500-16,000rpm
Net Weight	1.5kg



**M1902B** CB411  **€108.00**

Πλάνη 82mm

Planer 82mm

Input wattage	500W
Max. planing depth	2mm
Planing - width	82mm
No Load Speed	16,000rpm
Net Weight	2.7kg



M4000B



## UH4570

€214.00

Θαμνοκοπτικό 450mm

Electric Hedge Trimmer 450mm

Strokes per Minute	3200 min <sup>-1</sup>
Input Power	240V 550 W
No load speed	1600 min <sup>-1</sup>
Length Of Blade	450 mm
Max blade opening	18 mm
Tooth Spacing	18 mm
Weight	3,5kg



## UH6570

€263.00

Θαμνοκοπτικό 650mm

Electric Hedge Trimmer 650mm

Strokes per Minute	3200 min <sup>-1</sup>
Input Power	240V 550 W
No load speed	1600 min <sup>-1</sup>
Length Of Blade	650 mm
Max blade opening	18 mm
Tooth Spacing	28 mm
Weight	3,7kg



## UH6580

€313.50

Θαμνοκοπτικό 650mm

Electric Hedge Trimmer 650mm

Strokes per Minute	3000 min <sup>-1</sup>
Input Power	240V 670 W
No load speed	1500 min <sup>-1</sup>
Length Of Blade	650 mm
Max blade opening	18 mm
Tooth Spacing	28 mm
Weight	4,3kg



UH6580

## DUH502Z

€485.00

18V Θαμνοκοπτικό μπαταρίας 500mm

18V Hedge Trimmer 500mm

Strokes per Minute	2000 / 3600 / 4400 min <sup>-1</sup>
Length Of Blade	500 mm
Max blade opening	21,5 mm
Tooth Spacing	35 mm
Weight	3,5 kg

Δεν συμπεριλαμβάνει μπαταρία και φορτιστή  
Does not include battery and charger

**BL** MOTOR **LITHIUM-ION** **LXT**



## DUH523Z

€183.00

18V Θαμνοκοπτικό μπαταρίας 520mm

18V Hedge Trimmer 520mm

Strokes per Minute	2700 min <sup>-1</sup>
Length Of Blade	520 mm
Max blade opening	15 mm
Tooth Spacing	26 mm
Weight	2,7 kg

Δεν συμπεριλαμβάνει μπαταρία και φορτιστή  
Does not include battery and charger

**LITHIUM-ION** **LXT**



## DUH601Z

€509.00

18V Θαμνοκοπτικό μπαταρίας 600mm

18V Hedge Trimmer 600mm

Strokes per Minute	2000 / 3600 / 4400 min <sup>-1</sup>
Length Of Blade	600 mm
Max blade opening	23,5 mm
Tooth Spacing	35 mm
Weight	3,6 kg

Δεν συμπεριλαμβάνει μπαταρία και φορτιστή  
Does not include battery and charger

**BL** MOTOR **LITHIUM-ION** **LXT**



## DUH606Z

€409.00

18V Θαμνοκοπτικό μπαταρίας 600mm

18V Hedge Trimmer 600mm

Strokes per Minute	4000 min <sup>-1</sup>
Length Of Blade	600 mm
Max blade opening	20 mm
Tooth Spacing	30 mm
Weight	2,3 kg

Δεν συμπεριλαμβάνει μπαταρία και φορτιστή  
Does not include battery and charger

**BL** MOTOR **LITHIUM-ION** **LXT**



## DUH604SZ €658.00

18V Θαμνοκοπτικό μπαταρίας 600mm

18V Hedge Trimmer 600mm

Strokes per Minute	2000 / 3600 / 4400 min <sup>-1</sup>
Length Of Blade	600 mm
Max blade opening	23,5 mm
Tooth Spacing	35 mm
Weight	3,1 kg

Δεν συμπεριλαμβάνει μπαταρία και φορτιστή  
Does not include battery and charger

**BL** **LITHIUM-ION** **LXT**



DUH604SZ

## DUH607Z €274.00

18V Θαμνοκοπτικό μπαταρίας 600mm

18V Hedge Trimmer 600mm

**NEW**

Strokes per Minute	2700 min <sup>-1</sup>
Length Of Blade	600 mm
Max blade opening	15 mm
Tooth Spacing	28 mm
Weight	2,4 kg

Δεν συμπεριλαμβάνει μπαταρία και φορτιστή  
Does not include battery and charger

**LITHIUM-ION** **LXT**

## UH006GZ €510.00

40V Θαμνοκοπτικό μπαταρίας 600mm

40V Hedge Trimmer 600mm

**NEW**

Strokes per Minute	2000 / 3000 / 4000 min <sup>-1</sup>
Length Of Blade	600 mm
Max blade opening	25 mm
Tooth Spacing	38 mm
Weight	3,7 kg

Δεν συμπεριλαμβάνει μπαταρία και φορτιστή  
Does not include battery and charger

**XGT** **BL** **Motor**

## DUC150Z €306.00

18V Πριόνι κλαδέματος 150mm

18V Pruning Saw 150mm

Oil tank capacity	55mL
Bar length	150mm (6")
Max. Chain Speed	8,0 m/s
Max Output Power	320 W
Chain pitch	0.325"
Chain gauge	1.1mm (0.043")
Net Weight	1.1 kg

Δεν συμπεριλαμβάνει μπαταρία και φορτιστή  
Does not include battery and charger

**BL** **LITHIUM-ION** **LXT**



## UC100DZ €276.00

12V Πριόνι κλαδέματος 100mm

12V Pruning Saw 100mm

Oil tank capacity	55mL
Bar length	100mm (4")
Chain type	80TXL
Chain pitch	0.325"
Chain gauge	1.1mm (0.043")
Net Weight	1.3 kg

Δεν συμπεριλαμβάνει μπαταρία και φορτιστή  
Does not include battery and charger

**BL** **LITHIUM-ION** **12V<sub>max</sub>** **CXT**



## DUS054Z €286.00

18V Ψεκαστήρα 5L

18V Garden Sprayer 5L

Max Flow Rate	0,91 L/min
Max Pressure	3 bar
Hose length	1,7 m
Container Capacity	5 L
Weight	2,8 kg

Δεν συμπεριλαμβάνει μπαταρία και φορτιστή  
Does not include battery and charger

**LITHIUM-ION** **LXT**



UC100DZ

## UC4041A

€230.00

Αλυσσοπρίνο 16"

Electric Chainsaw 16"

Input Power	240V 1800 W
Max Output Power	2400 W
Max. Chain Speed	14,5 m/s
Chain bar length	400 mm (16")
Chain Pitch	3/8 "
Chain Gauge	1,1 / 1,3 mm
Oil Tank Capacity	200 ml
Weight	4,3kg



## UC4051A

€298.00

Αλυσσοπρίνο 16"

Electric Chainsaw 16"

Input Power	240V 2000 W
Max Output Power	2200 W
Max. Chain Speed	14,5 m/s
Chain bar length	400 mm (16")
Chain Pitch	3/8 "
Chain Gauge	1,3 mm
Oil Tank Capacity	200 ml
Weight	5,6kg



## DUC254Z

€389.00

18V Αλυσσοπρίνο μπαταρίας 10"/25cm

18V Chainsaw 10"/25cm

Max. Chain Speed	24,0 m/s
Chain bar length	250 mm (10")
Chain Pitch	3/8 / 0,325 "
Chain Gauge	0,043 "
Oil Tank Capacity	140 ml
Weight	2,0 kg



Δεν συμπεριλαμβάνει μπαταρία και φορτιστή  
Does not include battery and charger

**BL MOTOR LITHIUM-ION LXT**

## DUC353Z

€520.50

18V X2 Αλυσσοπρίνο 14"/35cm

18V X2 Chainsaw 14"/35cm

Max. Chain Speed	20,0 m/s
Chain bar length	350 mm (14")
Chain Pitch	3/8 "
Chain Gauge	0,043 "
Oil Tank Capacity	200 ml
Weight	3,3 kg



Δεν συμπεριλαμβάνει μπαταρία και φορτιστή  
Does not include battery and charger

**BL MOTOR LITHIUM-ION 18V X2 36V LXT**

## DUC307ZX2

€415.00

18V Αλυσσοπρίνο μπαταρίας 12"/30cm

18V Chainsaw 12"/30cm

Max. Chain Speed	7,7 m/s
Chain bar length	300 mm (12")
Chain Pitch	3/8 "
Chain Gauge	0,043 "
Oil Tank Capacity	150 ml
Weight	2,9 kg



Δεν συμπεριλαμβάνει μπαταρία και φορτιστή  
Does not include battery and charger

**BL MOTOR LITHIUM-ION LXT**

## UC003GZ

€556.00

40V Αλυσσοπρίνο μπαταρίας 300mm

40V Top Handle Chainsaw 300mm

Max. Chain Speed	24,8 m/s
Chain bar length	300 mm (12")
Chain Pitch	3/8 "
Chain Gauge	0,043 / 0,050 "
Oil Tank Capacity	200 ml
Weight	2,6 kg



Δεν συμπεριλαμβάνει μπαταρία και φορτιστή  
Does not include battery and charger

**XGT BL MOTOR WG WETGUARD**

## DUC306Z

€473.00

36V (18x2)V Αλυσσοπρίνο μπαταρίας 300mm

36V (18x2) Top Handle Chainsaw 300mm

Max. Chain Speed	20,0 / 20,6 m/s
Chain bar length	300 mm (12")
Chain Pitch	3/8 / 0,325 "
Chain Gauge	0,043 / 0,050 "
Oil Tank Capacity	200 ml
Weight	2,8 kg



Δεν συμπεριλαμβάνει μπαταρία και φορτιστή  
Does not include battery and charger

**LITHIUM-ION 18V X2 36V LXT BL MOTOR**

## UC012GZ

€382.00

40V Αλυσσοπρίνο μπαταρίας 400mm

40V Chainsaw 400mm

Max. Chain Speed	25,5 m/s
Chain bar length	400 mm (16")
Chain Pitch	3/8 / 0,325 "
Chain Gauge	1,1 / 1,3 mm
Oil Tank Capacity	260 ml
Weight	2,6kg



Δεν συμπεριλαμβάνει μπαταρία και φορτιστή  
Does not include battery and charger

**XGT BL MOTOR WG WETGUARD**

Metal Case » Chainsaw Accessories

Find in accessories section



**UA004GZ**



**€893.00**

40V Τηλεσκοπικό Αλυσσοπρίνο 300mm

40V Telescopic Pole Saw 300mm

Max. Chain Speed	20,0 m/s
Chain bar length	300 mm (12")
Chain Pitch	3/8"
Chain Gauge	1,1 mm
NO. of Drive Links	46
Oil Tank Capacity	160 ml
Weight	7,6 - 9,1 kg

Δεν συμπεριλαμβάνει μπαταρία και φορτιστή  
Does not include battery and charger

**XGT BL AFT**  
MOTOR

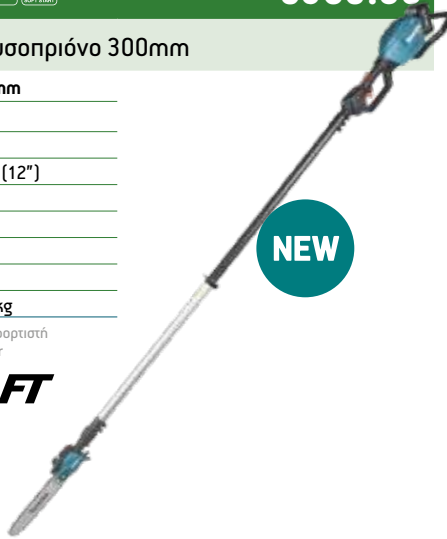

**NEW**

**UA003GZ**



**€495.00**

18V X2 Τηλεσκοπικό Αλυσσοπρίνο 250mm

18V X2 Telescopic Pole Saw 250mm

Max. Chain Speed	20,0 m/s
Chain bar length	300 mm (12")
Chain Pitch	3/8"
Chain Gauge	1.1 – 1.3 mm
NO. of Drive Links	46
Oil Tank Capacity	160 ml
Weight	6.1 – 7.4 kg

Δεν συμπεριλαμβάνει μπαταρία και φορτιστή  
Does not include battery and charger

**XGT BL AFT XPT WG**  
MOTOR WETGUARD



**NEW**

**DUN500WZ**



**€598.50**

18V Τηλεσκοπικό Θαμνοκοπτικό 500mm

18V Telescopic Pole Hedge Trimmer 500mm

Strokes per Minute	2000 / 3600 / 4400 min <sup>-1</sup>
Length Of Blade	500 mm
Max blade opening	23.5 mm
Angle range vertical	115°
Weight	3,6 kg

Δεν συμπεριλαμβάνει μπαταρία και φορτιστή  
Does not include battery and charger

**BL LITHIUM-ION LXT**  
MOTOR

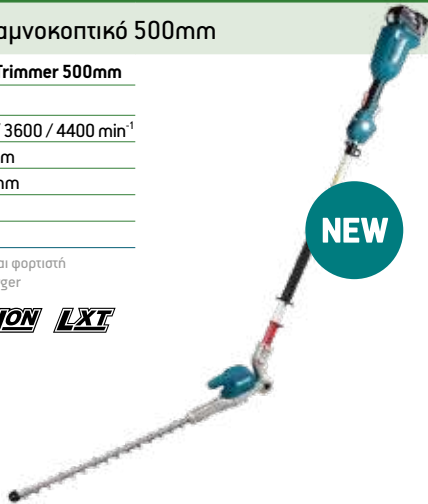

**NEW**

**DUR193Z**

**€196.00**

18V Χορτοκοπτικό μπαταρίας 260mm

18V Line Trimmer 260mm

Strokes per Minute	7800 min <sup>-1</sup>
Cutting width	260 mm
Line- Diameter	1,65 mm
Weight	2,0 kg

Δεν συμπεριλαμβάνει μπαταρία και φορτιστή  
Does not include battery and charger

**LITHIUM-ION LXT**



**DUR368AZ**



**€554.00**

18V X2 Θαμνοκοπτικό μπαταρίας 350mm

18V X2 Brush Cutter 350mm

Strokes per Minute	3500 / 5300 / 6500 min <sup>-1</sup>
Cutting width	230 / 255 / 350 mm
Line- Diameter	2.0 - 2.4 mm
Weight	3,4 kg

Δεν συμπεριλαμβάνει μπαταρία και φορτιστή  
Does not include battery and charger

**BL LITHIUM-ION 18V X2 36V LXT**  
MOTOR **ADT AFT XPT**



**DUR369AZ**



**€607.00**

18V X2 Θαμνοκοπτικό μπαταρίας 430mm

18V X2 Brush Cutter 350mm

Strokes per Minute	0-4600/5500/7000 min <sup>-1</sup>
Cutting width	255 / 305 / 430 mm
Line- Diameter	2.0 - 2.4 mm
Weight	5,2 kg

Δεν συμπεριλαμβάνει μπαταρία και φορτιστή  
Does not include battery and charger

**BL LITHIUM-ION 18V X2 36V LXT**  
MOTOR **ADT AFT XPT**

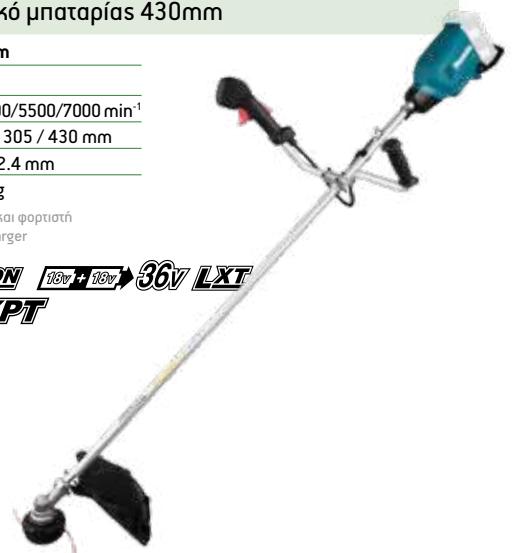

## UB100DZ



€105.50

12V Max Φυστήρας

12V Max Blower

Max air velocity	75 m/sec
Max air volume	2.6 m <sup>3</sup> /min
Max Sealed Suction	4.0 kPa
Vacuum function	✓
Air volume setting dial	3 settings
Net Weight	1.4 - 1.9 kg

Δεν συμπεριλαμβάνει μπαταρία και φορτιστή  
Does not include battery and charger

**LITHIUM-ION 12V<sub>max</sub> CXT**



## DUB185Z



€95.00

18V Φυστήρας

18V Blower

Max air velocity	98 m/sec
Max air volume	3.2 m <sup>3</sup> /min
Max Sealed Suction	5.8 kPa
Vacuum function	✓
Air volume setting dial	3 settings
Net Weight	1.6 - 2.1 kg

Δεν συμπεριλαμβάνει μπαταρία και φορτιστή  
Does not include battery and charger

**LITHIUM-ION LXT**



DUB184Z

## DUB184Z



€250.00

18V Φυστήρας

18V Brushless Blower

Max air volume	13.0 m <sup>3</sup> /min
Max air velocity	52.1 m/sec
No Load Speed	0 - 18,000 rpm
Net Weight	2.5 - 3.0 kg

Δεν συμπεριλαμβάνει μπαταρία και φορτιστή  
Does not include battery and charger

**BL MOTOR LITHIUM-ION LXT**



## DUB187Z



€335.00

18V Φυστήρας

18V Brushless Blower

Max. air Volume	4.2 <sup>3</sup> /min
Max. air Velocity	64 m/sec
Max. sealed suction	33 mbar
No Load Speed	9,000/ 13,500 rpm
Net Weight	2.96 kg

Δεν συμπεριλαμβάνει μπαταρία και φορτιστή  
Does not include battery and charger

**BL MOTOR LITHIUM-ION LXT**



## DUB362Z



€369.00

36 (18V x2) V Φυστήρας

36 (18V x2) Brushless Blower

Max. air Volume	13.4 <sup>3</sup> /min
Max. air Velocity	54 m/sec
No Load Speed	21,500/ 11,400 rpm
Net Weight	3.5 - 4.2 kg

Δεν συμπεριλαμβάνει μπαταρία και φορτιστή  
Does not include battery and charger

**BL MOTOR LITHIUM-ION 18V + 18V 36V LXT**



DUB187Z

Vacuum & Blower

## DUB363ZV



€515.00

36 (18V x2) V Φυστήρας

36 (18V x2) Brushless Blower

Max. Air Volume	13.4 <sup>3</sup> /min
Max. Air Velocity	65 m/sec
Vacuum function	✓
No Load Speed	0 - 7,850 rpm
Net Weight	4.5 - 6.6 kg

Δεν συμπεριλαμβάνει μπαταρία και φορτιστή  
Does not include battery and charger

**BL MOTOR LITHIUM-ION 18V + 18V 36V LXT**





ΕΠΙΣΗΜΟΣ ΔΙΑΝΟΜΕΑΣ



**Αδελφοί Ανδρέου**

Δεν είναι υποχρέωση σας  
να μας θυμάστε, αλλιά δική μας ευθύνη  
να μην μας ξεχάσετε!  
Μαζί σας και μετά την αγορά.

[www.andreou.com](http://www.andreou.com)



 **Andreou Brothers Ltd** |  **emboriko@andreou.com**  
 **Andreou Brothers Ltd** |  **80004100**

\* ΟΙ ΤΙΜΕΣ ΣΤΟ ΚΑΤΑΛΟΓΟ ΣΥΜΠΕΡΙΛΑΜΒΑΝΟΥΝ ΤΟ Φ.Π.Α. (19%).

Θα τα βρείτε σε συνεργάτες σε όλες τις πόλεις  
Με την υποστήριξη της Εταιρείας Αδελφοί Ανδρέου